

Rexroth IndraDyn S MSK Synchronous Motors

R911296289
Edition 05

Project Planning Manual



Title Rexroth IndraDyn S
MSK Synchronous Motors

Type of Documentation Project Planning Manual

Document Typecode DOK-MOTOR*-MSK*****-PR05-EN-P

Internal File Reference RS-e376b79b0a6846ac00f6d325fdb2ed7-1-en-US-6

Purpose of Documentation This documentation...

- explains the features of the product, operating conditions, conditions for use and operating limits for MSK motors.
- contains technical data regarding available MSK motors.
- provides information regarding product selection, handling and operation

Record of Revision

Edition	Release Date	Notes
DOK-MOTOR*-MSK*****-PR01-EN-P	06/2004	First edition
DOK-MOTOR*-MSK*****-PR02-EN-P	10/2004	Revision, amendment
DOK-MOTOR*-MSK*****-PR03-EN-P	02/2005	Revision, amendment, not printed
DOK-MOTOR*-MSK*****-PR04-EN-P	06/2005	Revision, amendment
DOK-MOTOR*-MSK*****-PR05-EN-P	03/2006	Revision, amendment

Copyright © 2006 Bosch Rexroth AG

Copying this document, giving it to others and the use or communication of the contents thereof without express authoruty, are forbidden. Offenders are liable for the payment of damages. All rights are reserved in the event of the grant of a patent or the registration of a utility model or design (DIN 34-1).

Validity The specified data is for product description purposes only and may not be deemed to be guaranteed unless expressly confirmed in the contract. All rights are reserved with respect to the content of this documentation and the availability of the product.

Published by Bosch Rexroth AG
Bgm.-Dr.-Nebel-Str. 2 ■ 97816 Lohr a. Main, Germany
Tel. +49 (0)93 52 / 40-0 ■ Fax +49 (0)93 52 / 40-48 85
<http://www.boschrexroth.com/>
Dept. BRC/EDM2 (JW)

Note This document has been printed on chlorine-free bleached paper.

Table of contents

	Page
1 Introduction.....	1
1.1 Introduction to the Product IndraDyn S.....	1
1.2 About this Documentation.....	2
2 Important Directions for Use	5
2.1 Appropriate Use	5
2.1.1 Introduction.....	5
2.1.2 Areas of Use and Application.....	5
2.2 Inappropriate Use	6
3 Safety Instructions for Electric Drives and Controls	7
3.1 Introduction.....	7
3.2 Explanation.....	7
3.3 General.....	7
3.4 Protection Against Contact with Electric Parts.....	9
3.5 Protection Against Electric Shock by Protective Extra-Low Voltage.....	10
3.6 Protection Against Dangerous Movements.....	10
3.7 Protection Against Magnetic and Electromagnetic Fields During Operation and Mounting.....	12
3.8 Protection Against Contact with Hot Parts.....	12
3.9 Protection During Handling and Mounting.....	12
3.10 Battery Safety.....	13
3.11 Protection Against Pressurized Systems.....	13
4 Technical Data.....	15
4.1 Definition of Parameters	15
4.1.1 60K and 100K Parameters.....	15
4.1.2 Operating Mode	15
4.1.3 Operating Time	16
4.1.4 Dimension Sheet Specifications.....	16
4.1.5 Example of a Characteristic Curve.....	18
4.2 MSK030B Technical Data.....	19
4.3 MSK030C Technical Data.....	21
4.4 MSK040B Technical Data.....	23
4.5 MSK040C Technical Data.....	25
4.6 MSK050B Technical Data.....	27
4.7 MSK050C Technical Data.....	30
4.8 MSK060B Technical Data.....	33
4.9 MSK060C Technical Data.....	36
4.10 MSK061C Technical Data.....	39
4.11 MSK070C Technical Data.....	41
4.12 MSK070D Technical Data.....	45
4.13 MSK070E Technical Data.....	49
4.14 MSK071D Technical Data.....	53

Table of contents

	Page
4.15	MSK071E Technical Data..... 58
4.16	MSK076C Technical Data..... 63
4.17	MSK100B Technical Data..... 66
4.18	MSK100C Technical Data..... 70
4.19	MSK100D Technical Data..... 74
4.20	MSK101D Technical Data..... 77
4.21	MSK101E Technical Data..... 82
5	Specifications..... 87
5.1	Basic Data – Technical Design 87
5.2	Size MSK030..... 88
5.3	Size MSK040..... 89
5.4	Size MSK050..... 90
5.5	Size MSK060..... 91
5.6	Size MSK061..... 92
5.7	Size MSK070..... 93
5.8	Size MSK071..... 94
5.9	Size MSK071 with Liquid Coolant..... 95
5.10	Size MSK076..... 96
5.11	Size MSK100..... 97
5.12	Size MSK101..... 98
5.13	Size MSK101 with Liquid Cooling..... 99
6	Type Codes..... 101
6.1	Description..... 101
6.2	Size MSK030..... 105
6.3	Size MSK040..... 107
6.4	Size MSK050..... 109
6.5	Size MSK060..... 111
6.6	Size MSK061..... 113
6.7	Size MSK070..... 115
6.8	Size MSK071..... 117
6.9	Size MSK076..... 119
6.10	Size MSK100..... 121
6.11	Size MSK101..... 123
7	Accessories and Options..... 125
7.1	Motor Encoder 125
7.1.1	General..... 125
7.1.2	Motor Encoder Technical Data..... 125
7.2	Holding Brakes..... 126
7.3	Fan Units for MSK Motors..... 126
7.3.1	Technical Data..... 126
7.3.2	Assignment..... 126
7.3.3	Electrical Connection, Adjust Motor Protection..... 127

Table of contents

	Page
7.3.4	Ordering..... 127
7.3.5	Specifications 129
	MSK060 fan unit axial..... 129
	MSK070 fan unit axial..... 130
	MSK071 fan unit axial..... 131
	MSK100 fan unit axial..... 132
	MSK101 fan unit axial..... 133
7.3.6	Assembly..... 134
	Fan unit LEM-AB-116N..... 134
	Fan unit LEM-AB-140N..... 135
	Fan unit LEM-AB-192N..... 136
7.4	Gearbox 136
7.5	Sealing Air Connection..... 136
8	Connection Techniques..... 141
8.1	General..... 141
8.2	Power Connector Size 1..... 142
8.2.1	RLS1100 Flange Socket..... 142
8.2.2	RLS1101 Power Connector 143
8.3	Power Connector Size 1.5..... 144
8.3.1	RLS1200 Flange Socket..... 144
8.3.2	RLS1201 Power Connector 145
8.4	Power Connector Size 2..... 147
8.4.1	RLS1300 Flange Socket..... 147
8.4.2	RLS1301 Power Connector 148
8.5	Encoder connector..... 150
8.5.1	RGS1000 Flange Socket, RGS1003 Flange Socket..... 150
8.5.2	RGS1001 Power Connector..... 151
8.6	Connection Cable..... 152
8.6.1	Dimensioning of Power Cables..... 152
8.6.2	Ready-Made Connection Cables..... 153
8.6.3	Cable Layout..... 153
8.6.4	Line Lengths..... 154
8.7	Motor Cooling System..... 154
8.7.1	Connection Techniques Fan Units..... 154
8.7.2	Connection Technique Liquid Cooling..... 154
9	Operating Conditions and Application Notes..... 157
9.1	Ambient Conditions 157
9.1.1	Setup elevation and ambient temperature 157
9.1.2	Humidity / Temperature 157
9.1.3	Vibration 158
9.1.4	Shock 158
9.2	Protection Class..... 159
9.3	Compatibility with Foreign Materials 160

Table of contents

	Page
9.4	Design and Installation Positions 160
9.5	Housing Varnish 161
9.6	Output Shaft 161
9.6.1	Smooth Shaft 161
9.6.2	Output Shaft with Key 162
9.6.3	Output Shaft with Shaft Sealing Ring 162
9.7	Bearing and Shaft Load 164
9.7.1	General..... 164
9.7.2	Radial Load, Axial Load 164
9.7.3	Bearing Lifetime 165
9.8	Attachment of Drive Elements 166
9.9	Holding Brakes 167
9.9.1	General..... 167
9.9.2	Dimension of Holding Brakes 168
	General..... 168
	Safety Notes Holding Brakes 169
9.9.3	Drive of Holding Brakes 169
9.10	Acceptances and Authorizations..... 169
9.10.1	CE-Sign 169
9.10.2	UR, cUR Listing 169
9.10.3	CCC (China Compulsory Certification)..... 170
9.11	Motor Cooling System..... 170
9.11.1	Natural Convection..... 170
9.11.2	Fan Units..... 170
9.11.3	Liquid cooling..... 170
	General..... 170
	Operating pressure 171
	Coolant 172
	Used Materials 173
	Coolant inlet temperature 173
9.12	Motor Temperature Overview..... 174
9.12.1	General..... 174
9.12.2	Temperature sensor 174
9.12.3	Temperature Model..... 174
10	Handling, Transport and Storage..... 175
10.1	Supplied Condition..... 175
10.1.1	General..... 175
10.1.2	Inspection at the Factory..... 175
10.1.3	Test on the Customer Side..... 175
10.2	Identification and Checking of the Supplied Goods..... 175
10.2.1	Shipping documents and delivery note..... 175
10.2.2	Name plate..... 176
10.3	Handling of the Equipment..... 176
10.4	Transport of the Equipment 177
10.5	Storage of the Equipment 178

	Page
11 Installation.....	179
11.1 Safety.....	179
11.2 Skilled Personnel.....	179
11.3 Mechanical Mounting – Motor Assembly.....	179
11.3.1 Mounting the Flange.....	179
11.3.2 Preparation.....	180
11.3.3 Assembly.....	180
11.4 Electrical Connection – Motor Connection.....	180
11.4.1 General.....	180
11.4.2 Connecting the Plug.....	181
11.4.3 Adjusting the Output Direction.....	181
12 Commissioning, Operation and Maintenance	183
12.1 Commissioning.....	183
12.2 Operation.....	183
12.3 Deactivation.....	183
12.4 Maintenance.....	184
12.4.1 General.....	184
12.4.2 Cleaning.....	184
12.4.3 Bearing.....	184
12.4.4 Connection Cable.....	185
12.4.5 Holding Brakes	185
12.5 Troubleshooting.....	186
12.6 Dismantling.....	186
12.7 Waste Disposal.....	186
13 Appendix.....	189
13.1 List of Standards.....	189
14 Service & Support.....	191
14.1 Helpdesk.....	191
14.2 Service Hotline.....	191
14.3 Internet.....	191
14.4 Helpful Information.....	191
Index.....	193

1 Introduction

1.1 Introduction to the Product IndraDyn S

IndraDyn S servomotors set new standards. Many innovations in synchronous servomotors combine past experiences and the most up-to-date motor technology to create a new standard.

IndraDyn S servomotors are characterized by

- dynamics
- a compact construction
- a high torque density
- an extremely high degree of precision due to new optical encoder systems

IndraDyn S motors are available in the following power spectrum:

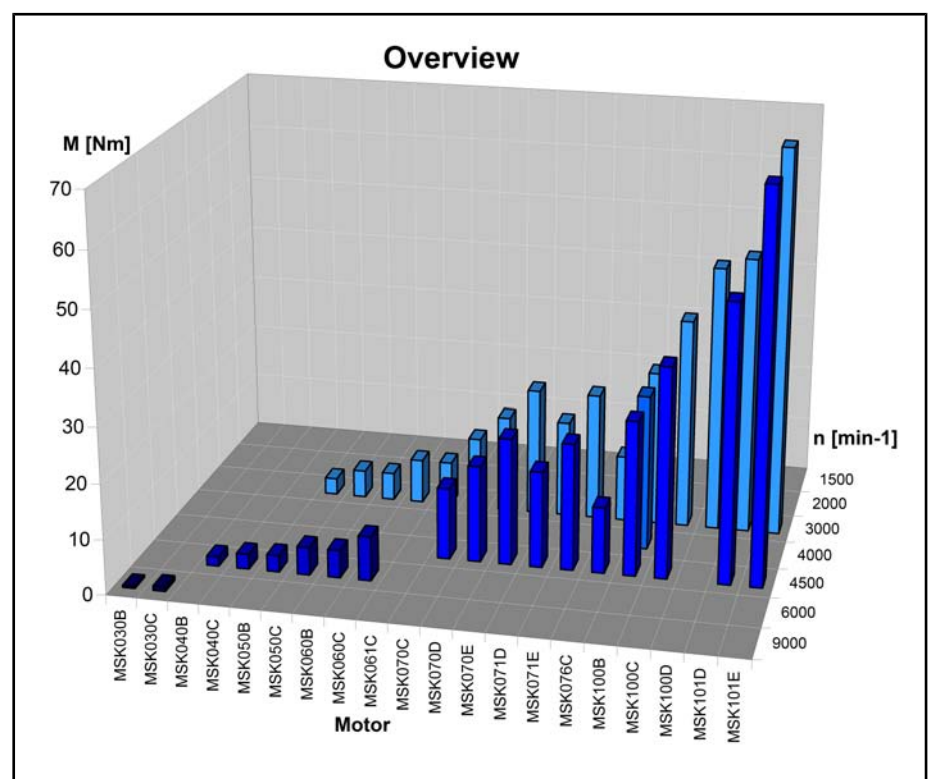

Fig. 1-1: MSK power graduation

Introduction

1.2 About this Documentation

Document Structure This documentation contains safety regulations, technical data and operating instructions for IndraDyn S motors. The individual chapters can be subdivided into the following focal points:

Section / Title	Contents
chapter 1 "Introduction" on page 1	General Information
chapter 2 "Important Directions for Use " on page 5	Safety
chapter 3 "Safety Instructions for Electric Drives and Controls " on page 7	
chapter 4 "Technical Data" on page 15	Product description (for planners and designers)
chapter 5 "Specifications" on page 87	
chapter 6 "Type Codes" on page 101	
chapter 7 "Accessories and Options" on page 125	
chapter 8 "Connection Techniques" on page 141	
chapter 9 "Operating Conditions and Application Notes" on page 157	
chapter 10 "Handling, Transport and Storage" on page 175	In Practice (for operating and maintenance personnel)
chapter 11 "Installation" on page 179	
chapter 12 "Commissioning, Operation and Maintenance " on page 183	
chapter 13 "Appendix" on page 189	General Information
chapter 14 "Service & Support" on page 191	
Index	

Fig. 1-2: Document Structure

Additional documentation

If required, you need additional documentation referring the used devices, to project the drive-systems of the MSK motor unit. Rexroth provides all product documentation on DVD in a PDF-format. You will not need all the documentation included on the DVD to project a system.



All documentation on the DVD are also available in a printed version. You can order the required product documentation via your Rexroth sales office.

MNR	Title / Designation
R911306531	-Product documentation Electric Drives and Controls Version xx ¹⁾ DOK-GENERL-DRIVE*CONTR-GNxx-D0-V04G7

1) The index (16, for example) identifies the version of the DVD.

Fig. 1-3: Additional documentation on DVD

Standards

This documentation refers to German, European and international technical standards. Documents and sheets on standards are subject to copyright protection and may not be passed on to third parties by Rexroth. If necessary, please address the authorized sales outlets or, in Germany, directly to:

BEUTH Verlag GmbH

Burggrafenstrasse 6**10787 Berlin, Germany**

Phone +49-(0)30-26 01-22 60, Fax +49-(0)30-26 01-12 60

Internet: <http://www.din.de/beuth>Email: postmaster@beuth.de

Foreign systems Documentation for external systems which are connected to Rexroth components are not included in the scope of delivery and must be ordered directly from the particular manufacturers.

Feedback Your experiences are an essential part of the process of improving both the product and the documentation.

Please do not hesitate to inform us of any mistakes you detect in this documentation or of any modifications you might desire. We would appreciate your feedback.

Please send your remarks to:

Bosch Rexroth AG

Dep. BRC/EDM2

Buergermeister-Dr.-Nebel-Strasse 2

97816 Lohr, Germany

Fax +49 (0) 93 52 / 40-43 80

2 Important Directions for Use

2.1 Appropriate Use

2.1.1 Introduction

Rexroth products represent state-of-the-art developments and manufacturing. They are tested prior to delivery to ensure operating safety and reliability.



Personal injury and property damage caused by inappropriate use of the products!

The products may only be used in the manner that is defined as appropriate. If they are used in an inappropriate manner, then situations can develop that may lead to property damage or injury to personnel.



Rexroth, as manufacturer, is not liable for any damages resulting from inappropriate use. In such cases, the guarantee and the right to payment of damages resulting from inappropriate use are forfeited. The user alone carries all responsibility of the risks.

Before using Rexroth products, make sure that all the pre-requisites for appropriate use of the products are satisfied:

- Personnel that in any way, shape or form uses our products must first read and understand the relevant safety instructions and be familiar with appropriate use.
- If the product takes the form of hardware, then they must remain in their original state, in other words, no structural changes are permitted. It is not permitted to decompile software products or alter source codes.
- Do not mount damaged or faulty products or use them in operation.
- Make sure that the products have been installed in the manner described in the relevant documentation.

2.1.2 Areas of Use and Application

Motors of the MSK line made by Rexroth are designed to be used as rotary main and servo drives, as linear drives, or as kit motors. Typical applications are:

- Machine tools
- Printing and paper processing machines
- Packaging and foodstuff machines
- Metal-forming machine tools

To ensure an application-specific use, the motors are available with differing drive power and different interfaces.

Control and monitoring of motors may require additional sensors and actors.



MSK may only be used with the accessories and parts specified in this document. If a component has not been specifically named, then it may not be either mounted or connected. The same applies to cables and lines.

Operation is only permitted in the specified configurations and combinations of components using the software and firmware as specified in the relevant function descriptions.

Important Directions for Use

Every connected drive controller has to be programmed before starting it up, making it possible for the motor to execute the specific functions of an application.

MSK may only be operated under the assembly, installation and ambient conditions as described here (temperature, system of protection, humidity, EMC requirements, etc.) and in the position specified.

2.2 Inappropriate Use

Using MSK outside of the above-referenced areas of application or under operating conditions other than described in the document and the technical data specified is defined as "inappropriate use".

MSK may not be used if

- they are subject to operating conditions that do not meet the above specified ambient conditions. This includes, for example, operation under water, in the case of extreme temperature fluctuations or extremely high maximum temperatures or if
- Rexroth has not specifically released them for that intended purpose. Please note the specifications outlined in the general safety instructions!

3 Safety Instructions for Electric Drives and Controls

3.1 Introduction

Read at first the following notes before startup procedure to avoid personal injury and/or material damages! This safety notes are always to be observed.

Do not try to install this machine or take into commission before you haven't read all delivered documentations exactly. This safety instructions and all other user notes must always been read before working with this machine. Should you have no user notes for this machine, please contact your responsible sales representative at Rexroth Indramat. Ask for prompt sending of this documentations to the responsible person to use this machine safely.

You have to pass this safety notes when you sell, lend out or otherwise pass this machine.



Improper use of this equipment, failure to follow the attached safety instructions, or tampering with the product, including disabling or disconnection the safety device, may result in injury, severe electrical shock or death and material damage!

Observe the following instructions.

3.2 Explanation

The safety instructions describe the following degrees of hazard seriousness. The degree of hazard seriousness informs about the consequences resulting from non-compliance with the safety instructions:



Warning symbols with signal word	Hazard classification (according to ANSI Z 535)
 DANGER	Death or severe bodily injury will occur.
 WARNING	Death or severe bodily injury may occur.
 CAUTION	Bodily injury or damage may occur.

Fig.3-1: Danger classes (according to ANSI Z 535)

3.3 General

- Bosch Rexroth AG is not liable for damages resulting from failure to observe the warnings provided in this documentation.
- Read the operating, maintenance and safety instructions in your language before commissioning the machine. If you find that you cannot completely understand the documentation for your product, please ask your supplier to clarify.

Safety Instructions for Electric Drives and Controls

- Proper and correct transport, storage, assembly and installation, as well as care in operation and maintenance, are prerequisites for optimal and safe operation of this device.
- Only assign trained and qualified persons to work with electrical installations:
- Only persons who are trained and qualified for the use and operation of the device may work on this device or within its proximity. The persons are qualified if they have sufficient knowledge of the assembly, installation and operation of the product, as well as an understanding of all warnings and precautionary measures noted in these instructions.
- Furthermore, they must be trained, instructed and qualified to switch electrical circuits and devices on and off in accordance with technical safety regulations, to ground them and to mark them according to the requirements of safe work practices. They must have adequate safety equipment and be trained in first aid.
- Only use spare parts and accessories approved by the manufacturer.
- Follow all safety regulations and requirements for the specific application as practiced in the country of use.
- The devices have been designed for installation in industrial machinery.
- The ambient conditions given in the product documentation must be observed.
- Only use safety-relevant applications that are clearly and explicitly approved in the Project Planning Manual. For example, the following operating conditions and fields of application are excluded: cranes, passenger and freight elevators, equipments and vehicles for passenger transportation, medical applications, refinery, transport of dangerous goods, nuclear applications, use in high-frequency sensitive areas, mining, food processing, control of protective devices (even in machines).
- The information given in the documentation of the product with regard to the use of the delivered components contains only examples of applications and suggestions.

The machine and installation manufacturer must

- make sure that the delivered components are suited for his individual application and check the information given in this documentation with regard to the use of the components,
 - make sure that his application complies with the applicable safety regulations and standards and carry out the required measures, modifications and complements.
- Commissioning of the delivered components is only permitted once it is sure that the machine or installation in which they are installed complies with the national regulations, safety specifications and standards of the application.
 - Operation is only permitted if the national EMC regulations for the application are met.

For notes regarding an EMC-compatible installation, refer to the documentation "EMC at AC Drives and Controls".

The machine or installation manufacturer is responsible for compliance with the limiting values as prescribed in the national regulations.

- Technical data, connection and installation conditions are specified in the product documentation and must be followed at all times.

3.4 Protection Against Contact with Electric Parts



This section only concerns devices and drive components with voltages of more than 50 Volt.

Contact with parts conducting voltages above 50 volts can cause personal danger and electric shock. When operating electrical equipment, it is unavoidable that some parts of the units conduct dangerous voltage.



High electrical voltage! Danger to life, electric shock and severe bodily injury!

- ⇒ Only those trained and qualified to work with or on electrical equipment are permitted to operate, maintain and repair this equipment.
- ⇒ Follow general construction and safety regulations when working on electrical power installations.
- ⇒ Before switching on the device, the equipment grounding conductor must have been permanently connected to all electrical equipment in accordance with the connection diagram.
- ⇒ Do not operate electrical equipment at any time, even for brief measurements or tests, if the equipment grounding conductor is not permanently connected to the mounting points of the components provided for this purpose.
- ⇒ Before working with electrical parts with voltage potentials higher than 50 V, the device must be disconnected from the mains voltage or power supply unit. Provide a safeguard to prevent reconnection.

For electrical drive and filter components, observe the following:

Wait 30 minutes after switching off power to allow capacitors to discharge before beginning to work. Measure the voltage on the capacitors before beginning to work to make sure that the equipment is safe to touch.

- ⇒ Never touch the electrical connection points of a component while power is turned on.
- ⇒ Install the covers and guards provided with the equipment properly before switching the device on. Before switching the equipment on, cover and safeguard live parts safely to prevent contact with those parts.
- ⇒ A residual-current-operated circuit-breaker or r.c.d. cannot be used for electric drives! Indirect contact must be prevented by other means, for example, by an overcurrent protective device according to the relevant standards.
- ⇒ Secure built-in devices from direct touching of electrical parts by providing an external housing, for example a control cabinet.

European countries: according to EN 50178/1998, section 5.3.2.3.

USA: See National Electric Code (NEC), National Electrical Manufacturers Association (NEMA) as well as local building regulations. The user must always keep all named articles.

For electrical drive and filter components, observe the following:

**DANGER****High housing voltage and high leakage current! Risk of death or bodily injury by electric shock!**

⇒ Before switching on, the housings of all electrical equipment and motors must be connected or grounded with the equipment grounding conductor to the grounding points. This is also applicable before short tests.

⇒ The equipment grounding conductor of the electrical equipment and the devices must be non-detachably and permanently connected to the power supply unit at all times. The leakage current is greater than 3.5 mA.

⇒ Over the total length, use copper wire of a cross section of a minimum of 10 mm² for this equipment grounding connection!

⇒ Before commissioning, also in trial runs, always attach the equipment grounding conductor or connect to the ground wire. Otherwise, high voltages may occur at the housing causing electric shock.

3.5 Protection Against Electric Shock by Protective Extra-Low Voltage

All connections and terminal connectors with a voltage of 5 to 50 Volt on Rexroth Indramat products are protective extra-low voltages, which are performed safe from touch according to the product standards

**WARNING****High electric voltage by incorrect connection! Risk of death or bodily injury by electric shock!**

⇒ Connect only devices with connectors and terminal connectors with a voltage of 0 to 50 volt, which have a protective extra-low voltage (PELV).

⇒ Connect only voltages and circuits, which have a safe disconnection to dangerous voltages. A safe disconnection can be done, for example, by isolating transformers, safe optocouplers or operation from battery.

3.6 Protection Against Dangerous Movements

Dangerous movements can be caused by faulty control of connected motors. Some common examples are:

- improper or wrong wiring of cable connections
- incorrect operation of the equipment components
- wrong input of parameters before operation
- malfunction of sensors, encoders and monitoring devices
- defective components
- software or firmware errors

These errors can occur immediately after equipment is switched on or even after an unspecified time of trouble-free operation.

The monitoring in the drive components will normally be sufficient to avoid faulty operation in the connected drives. Regarding personal safety, especially the danger of bodily harm and/or material damage, this alone cannot be relied upon to ensure complete safety. Until the integrated monitoring functions become effective, it must be assumed in any case that faulty drive movements will occur. The extent of faulty drive movements depends upon the type of control and the state of operation.



Dangerous movements! Danger to life, risk of injury, severe bodily harm or material damage!

⇒ For the above reasons, ensure personal safety by means of qualified and tested higher-level monitoring devices or measures integrated in the installation.

They have to be provided for by the user according to the specific conditions within the installation and a hazard and fault analysis. The safety regulations applicable for the installation have to be taken into consideration. Unintended machine motion or other malfunction is possible if safety devices are disabled, bypassed or not activated.

To avoid accidents, bodily harm and/or material damage:

⇒ Keep free and clear of the machine's range of motion and moving parts. Possible measures to prevent people from accidentally entering the machine's range of motion:

- use safety fences
- use safety guards
- use protective coverings
- install light curtains or light barriers

⇒ Fences and coverings must be strong enough to resist maximum possible momentum.

⇒ Mount the emergency stop switch in the immediate reach of the operator. Verify that the emergency stop works before commissioning. Do not operate the device if the emergency stop switch is not working.

⇒ Isolate the drive power connection by means of an emergency stop circuit or use a safety related starting lockout to prevent unintentional start.

⇒ Make sure that the drives are brought to a safe standstill before accessing or entering the danger zone.

⇒ Additionally secure vertical axes against falling or dropping after switching off the motor power by, for example:

- mechanically securing the vertical axes,
- adding an external braking/arrester/clamping mechanism or
- ensuring sufficient equilibration of the vertical axes.

The standard equipment motor brake or an external brake controlled by the drive controller are not sufficient to guarantee personal safety!

⇒ Disconnect electrical power to the equipment using a master switch and secure the switch against reconnection for:

- maintenance and repair work
- cleaning of equipment
- long periods of discontinued equipment use

⇒ Prevent the operation of high-frequency, remote control and radio equipment near electronics circuits and supply leads. If the use of such devices cannot be avoided, verify the system and the installation for possible malfunctions in all possible positions of normal use before initial commissioning. If necessary, perform a special electromagnetic compatibility (EMC) test on the installation.

3.7 Protection Against Magnetic and Electromagnetic Fields During Operation and Mounting

Magnetic and electromagnetic fields generated by current-carrying conductors and permanent magnets in motors represent a serious personal danger to those with heart pacemakers, metal implants and hearing aids.



WARNING

Health hazard for persons with heart pacemakers, metal implants and hearing aids in proximity to electrical equipment!

⇒ Persons with heart pacemakers and metal implants are not permitted to enter following areas:

- Areas in which electrical equipment and parts are mounted, being operated or commissioned.
- Areas in which parts of motors with permanent magnets are being stored, repaired or mounted.

⇒ If it is necessary for somebody with a pacemaker to enter such an area, a doctor must be consulted prior to doing so. The noise immunity of present or future implanted heart pacemakers differs greatly so that no general rules can be given.

⇒ Those with metal implants or metal pieces, as well as with hearing aids, must consult a doctor before they enter the areas described above. Otherwise health hazards may occur.

3.8 Protection Against Contact with Hot Parts



WARNING

Danger of burning via hot surfaces with temperatures over 100°C!

⇒ Touch the motor only after cooling! A cooling time up to 140 minutes can be necessary! The stated thermal time constant in the technical data is a measure for the necessary cooling

⇒ Do not work on hot surfaces.

⇒ Use safety gloves.



CAUTION

Hot surfaces on device housing! Danger of injury! Danger of burns!

⇒ Do not touch the housing surface near a hot heat source! Danger of burns!

⇒ After switching devices off, wait 10 minutes to allow them to cool down before touching them.

⇒ Touching hot parts of the machine, like the housing which contains the heat sink and resistances, could lead to combustions!

3.9 Protection During Handling and Mounting

In unfavorable conditions, handling and mounting certain parts and components in an improper way can cause injuries.



Risk of injury by improper handling! Bodily injury by bruising, shearing, cutting, hitting!

- ⇒ Observe the general construction and safety regulations on handling and mounting.
- Use suitable devices for mounting and transport.
- ⇒ Avoid jamming and bruising by appropriate measures.
- ⇒ Always use suitable tools. Use special tools if specified.
- ⇒ Use lifting equipment and tools in the correct manner.
- ⇒ If necessary, use suitable protective equipment (for example safety goggles, safety shoes, safety gloves).
- ⇒ Do not stand under hanging loads.
- ⇒ Immediately clean up any spilled liquids because of the danger of skidding.

3.10 Battery Safety

Batteries consist of active chemicals enclosed in a solid housing. Therefore, improper handling can cause injury or material damage.



Risk of injury by improper handling!

- ⇒ Do not attempt to reactivate low batteries by heating or other methods (risk of explosion and cauterization).
- ⇒ Do not recharge the batteries as this may cause leakage or explosion.
- ⇒ Do not throw batteries into open flames.
- ⇒ Do not dismantle batteries.
- ⇒ Do not damage electrical parts which are mounted into the devices.



Environmental protection and disposal! The batteries contained in the product are considered dangerous goods during land, air, and sea transport (risk of explosion) in the sense of the legal regulations. Dispose of used batteries separate from other waste. Observe the local regulations in the country of assembly.

3.11 Protection Against Pressurized Systems

According to the information given in the Project Planning Manuals, some IndraDyn motors, as well as drive controllers, can be partially supplied with externally fed, pressurized media, such as compressed air, hydraulics oil, cooling liquids and cooling lubricating agents. Improper handling of the external supply systems, supply lines or connections can cause injuries or material damage.



Risk of injury by improper handling of pressurized lines!

- ⇒ Do not attempt to disconnect, open or cut pressurized lines (risk of explosion).
- ⇒ Observe the respective manufacturer's operating instructions.
- ⇒ Before dismantling lines, relieve pressure and empty medium.
- ⇒ Use suitable protective equipment (for example safety goggles, safety shoes, safety gloves).
- ⇒ Immediately clean up any spilled liquids from the floor.

Safety Instructions for Electric Drives and Controls



Environmental protection and disposal! The agents used to operate the product might not be economically friendly. Dispose of ecologically harmful agents separately from other waste. Observe the local regulations in the country of assembly.

4 Technical Data

4.1 Definition of Parameters

4.1.1 60K and 100K Parameters

The speed-torque curves and the technical data are specified for two different temperature models.

- 60K temperature stroke on the housing and
- 100K temperature stroke on the winding



When selecting the technical data, observe the temperatures specified! The appropriate parameters are identified by **100K** or **60K**.

Setup and measurement of the 60K characteristic curve

The motor data and characteristic curves for IndraDyn S motors are determined under the following conditions:

- Environmental temperature approx. 40°C
- Insulated structure (aluminum flange)
- Permissible temperature increase on the housing $\Delta T = 60K$
- In the case of motors with the optional holding brake, the data are always specified for motors **with** a holding brake.
- Motors with radial shaft sealing ring

Setup and measurement of the 100K characteristic curve

The motor data and characteristic curves for IndraDyn S motors are determined under the following conditions:

- Environmental temperature approx. 40°C
- Structure **not** insulated (attachment to steel flange, LxWxH = 450x30x350 or 120x40x100)
- Permissible temperature increase on the winding $\Delta T = 100K$
- In the case of motors with the optional holding brake, the data are always specified for motors **with** a holding brake.
- Motors with radial shaft sealing ring



The machine accuracy can be negatively affected by an increased linear expansion during 100K operation. We recommend using 60K data when projecting systems.

4.1.2 Operating Mode

IndraDyn S motors are documented according to the inspection criteria and measurement procedures of EN 60034-1. The specified characteristic curves correspond to operating modes S1 or S3.

Technical Data

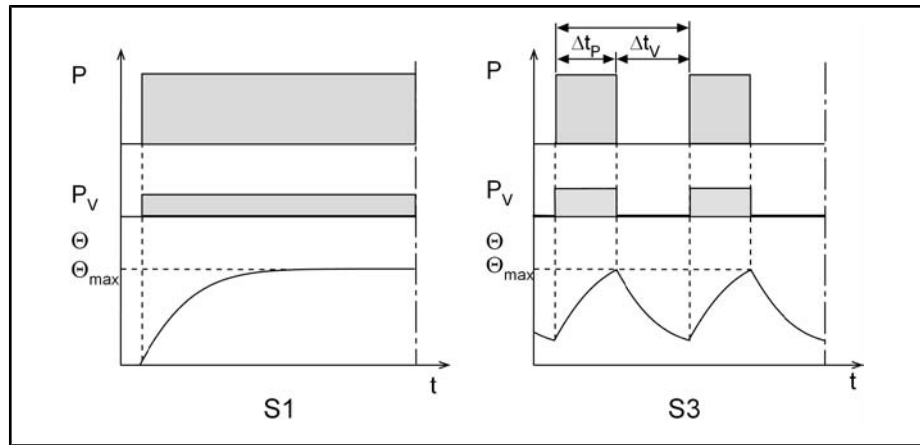

P Load
 Pv Electric losses
 Θ Temperature
 Θmax Highest temperature (motor housing)
 t Time
 TC Cycle time
 ΔtP Operating time with constant load
 ΔtV Idle time

Fig.4-1: Operating modes according to EN 60034-1:1998

4.1.3 Operating Time

Operating mode S3 is supplemented by specification of the ON time (ED) in %. The operating time is calculated as follows:

$$ED = \frac{\Delta t_P}{T_C} \cdot 100\%$$

ED Cyclic duration factor in %
 ΔtP Operating time with constant load

Fig.4-2: Cyclic duration factor

The values specified in the documentation have been determined on the basis of the following parameters:

Cycle duration: 10 min

Cyclic duration factor (ED): 25%

4.1.4 Dimension Sheet Specifications

Standstill continuous torque The permanent shaft load on the motor output shaft at speed $n \approx 0$. The different operating modes are indicated by the following indices:

M_{0_60} Continuous torque at standstill, 60K

M_{0_100} Continuous torque at standstill, 100K

M_{0_S} Standstill continuous torque surface

M_{0_L} Continuous torque at standstill, liquid

Continuous stand-still current For the continuous torque at standstill M_0 necessary phase current (effective value) of the motor at a speed of $n \approx 0$. The various operating modes are indicated by the following indices.

I_{0_60(eff)} Continuous current at standstill, 60K

I_{0_100(eff)} Continuous current at standstill, 100K

	$I_{0_S(eff)}$	Standstill continuous torque surface
	$I_{0_L(eff)}$	Continuous current at standstill, liquid
Maximum torque	M_{max}	The maximum torque that can be output for approx. 400 ms at a maximum current of I_{max} (guaranteed value which, owing to production tolerances, may be up to 20% higher). The achievable maximum torque depends on the drive controller used. Only the specified maximum torque in the selection lists is binding.
Peak current	$I_{max(eff)}$	Maximum short-term branch current (root-mean-square value) of the motor permitted without damaging the permanent magnetic circuit of the motor.
Torque constant at 20°C	K_{M_N}	Ratio of the torque to the motor phase current (root-mean-square value) at a motor temperature of 20°C. Unit Nm/A. Valid up to approx. $i = 2 \times I_{0_60(eff)}$.
Constant voltage at 20°C	K_{EMK_1000}	Root-mean-square value of the induced motor voltage at a motor temperature of 20°C and 1000 revolutions per minute. Unit: V/1000min ⁻¹ .
Winding resistance at 20°C	R_{12}	Resistance measured between two winding ends in ohms (Ω).
Winding inductivity	L_{12}	Inductivity measured between two winding ends in mH.
Discharge capacity	C_{ab}	Capacity of short-circuited power connections U, V, W against the motor housing.
Number of pole pairs	p	Number of pole pairs of the motor.
Moment of inertia of rotor	J_{rot}	Moment of inertia of the rotor without the optional holding brake.
Maximum torque	n_{max}	Maximum permissible speed of the motor. Limiting factors can have mechanical (centrifugal forces, bearing stress) or electrical (DC link voltage) causes.
Mass	m	Motor mass without the holding brake option, given in kg.
Sound pressure level	L_p	Airborne noise emitted, in dB(A).

Technical Data

4.1.5 Example of a Characteristic Curve

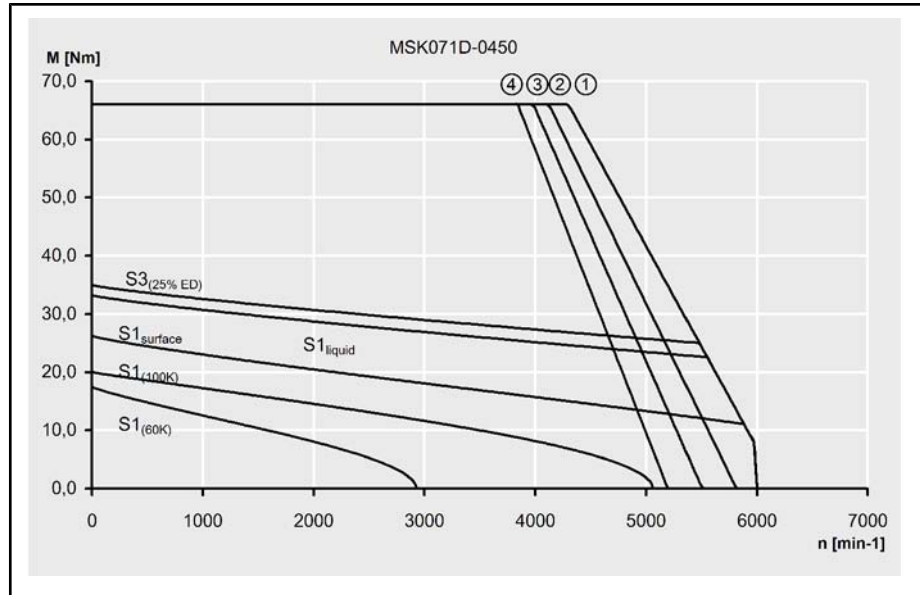

- S1 (60K) Continuous operation curve of the motor (according to EN 60034-1; 1998), natural convection
- S1 (100K) Continuous operation curve of the motor (according to EN 60034-1; 1998), natural convection
- S1 (surface) Continuous operation curve S1 of the motor (according to EN 60034-1; 1998), surface cooling.
- S3 (25% ED) Intermittent service characteristic curve at 25% operating rate of the motor (according to EN 60034-1; 1998) and max. cycle time of 10 min.
- ① - ④ Characteristic voltage limit curves When a speed at the safe commutation limit is reached, the voltage limit curve limits the available maximum torque M_{max} . The maximum motor speed is determined by the DC link voltage used. There are separate characteristic curves for the various drive controllers in connection with the power supply unit and the supply voltage used.
- ① M_{max} for IndraDrive, controlled feed, 3 x AC 400V
- ② M_{max} for IndraDrive, uncontrolled feed, 3 x AC 480V
- ③ M_{max} for IndraDrive, uncontrolled feed, 3 x AC 440V
- ④ M_{max} for IndraDrive, uncontrolled feed, 3 x AC 400V

Fig.4-3: Example of a motor characteristic curve

4.2 MSK030B Technical Data

Description	Symbol	Unit	MSK030B-0900-NN
Continuous torque at standstill, 60K	M_{0_60}	Nm	0,4
Continuous current at standstill, 60K	$I_{0_60(\text{eff})}$	A	1,5
Continuous torque at standstill, 100K	M_{0_100}	Nm	0,4
Continuous current at standstill, 100K	$I_{0_100(\text{eff})}$	A	1,7
Maximum torque	M_{max}	Nm	1,8
Maximum current	$I_{\text{max}(\text{eff})}$	A	6,8
Torque constant at 20°C	K_{M_N}	Nm/A	0,29
Constant voltage at 20°C	K_{EMK_1000}	V/min ⁻¹	17,9
Winding resistance at 20°C	R_{12}	Ohm	7,20
Winding inductivity	L_{12}	mH	8,100
Leakage capacitance of the component	C_{ab}	nF	0,7
Number of pole pairs	p	-	3
Moment of inertia of rotor without brake ¹⁾	J_{rot}	kg*m ²	0,00001
Thermal time constant	T_{th}	min	19,0
Maximum speed	n_{max}	min ⁻¹	9000
Sound pressure level	L_p	dB[A]	<75
Ambient temperature during operation	T_{um}	°C	0 ... 40
Degree of protection		-	IP65
Insulation class EN 60034-1		-	F

1) Specified without brake. If necessary, add the moment of inertia brake.
 Fig.4-4: Technical data

Description	Symbol	Unit	BREMSE-231389
holding torque	M_4	Nm	1,0
rated voltage ±10%	U_N	V	24
rated current	I_N	A	0,40
connection time	t_1	ms	3
disconnection time	t_2	ms	4
moment of inertia brake	J_{rot}	kg*m ²	0,000007
mass brake	M_{Br}	kg	0,2

Fig.4-5: MSK030: Holding brake - Technical data (optional)

Technical Data

Speed-torque characteristic

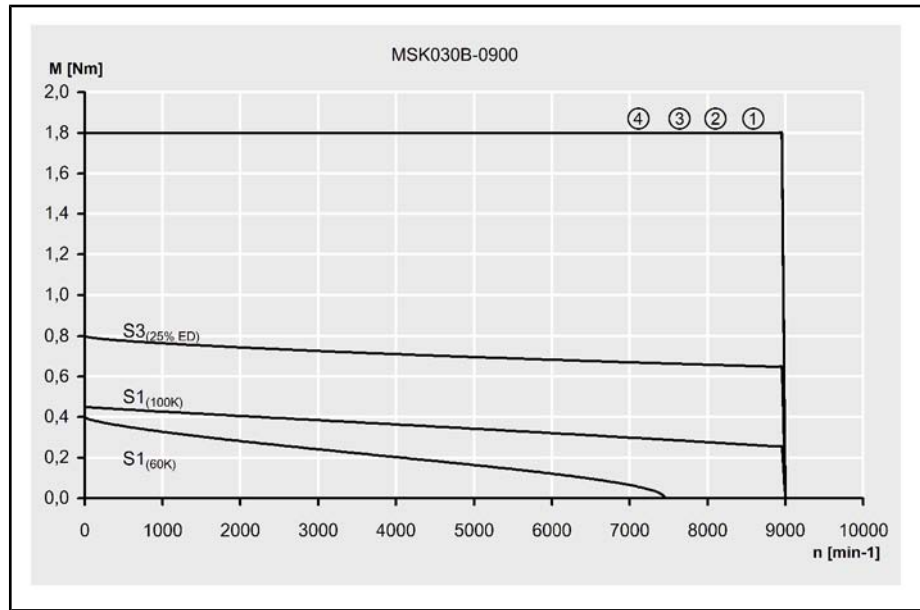

- ① Mmax for IndraDrive, controlled feed, 3x AC 400V
- ② Mmax for IndraDrive, uncontrolled feed, 3x AC 480V
- ③ Mmax for IndraDrive, uncontrolled feed, 3x AC 440V
- ④ Mmax for IndraDrive, uncontrolled feed, 3x AC 400V

Fig.4-6: Speed-torque characteristic of MSK030B-0900

Shaft load

Diagram for determining the maximum permissible radial force F_{radial} .

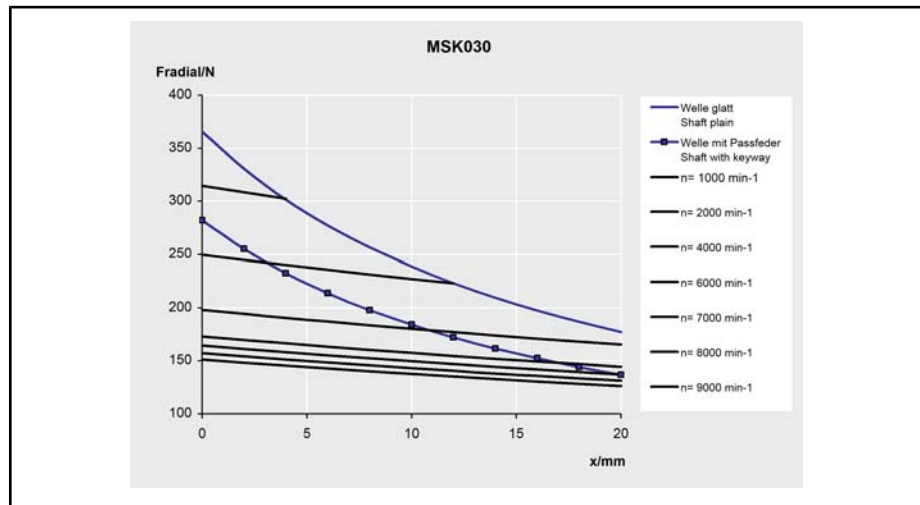

Fig.4-7: permissible radial force of MSK030 - Motors (shaft and bearing load)

The maximum permissible axial force F_{axial} is 50 N.

For additional information about permissible radial and axial forces, see [chapter 9.7 "Bearing and Shaft Load"](#) on page 164.

4.3 MSK030C Technical Data

Description	Symbol	Unit	MSK030C-0900-NN
Continuous torque at standstill, 60K	M_{0_60}	Nm	0,8
Continuous current at standstill, 60K	$I_{0_60(\text{eff})}$	A	1,5
Continuous torque at standstill, 100K	M_{0_100}	Nm	0,9
Continuous current at standstill, 100K	$I_{0_100(\text{eff})}$	A	1,7
Maximum torque	M_{max}	Nm	4,0
Maximum current	$I_{\text{max}(\text{eff})}$	A	6,8
Torque constant at 20°C	K_{M_N}	Nm/A	0,58
Constant voltage at 20°C	K_{EMK_1000}	V/min ⁻¹	35,6
Winding resistance at 20°C	R_{12}	Ohm	9,80
Winding inductivity	L_{12}	mH	14,100
Leakage capacitance of the component	C_{ab}	nF	1,3
Number of pole pairs	p	-	3
Moment of inertia of rotor without brake ¹⁾	J_{rot}	kg*m ²	0,00003
Thermal time constant	T_{th}	min	15,0
Maximum speed	n_{max}	min ⁻¹	9000
Sound pressure level	L_p	dB[A]	<75
Ambient temperature during operation	T_{um}	°C	0 ... 40
Degree of protection		-	IP65
Insulation class EN 60034-1		-	F

1) Specified without brake. If necessary, add the moment of inertia brake.
Fig.4-8: Technical data

Description	Symbol	Unit	BREMSE-231389
Holding torque	M_4	Nm	1,0
Rated voltage ±10%	U_N	V	24
Rated current	I_N	A	0,40
Connection time	t_1	ms	3
Disconnection time	t_2	ms	4
Moment of inertia brake	J_{rot}	kg*m ²	0,000007
Mass brake	M_{Br}	kg	0,2

Fig.4-9: MSK030: Holding brake - Technical data (optional)

Technical Data

Speed-torque characteristic

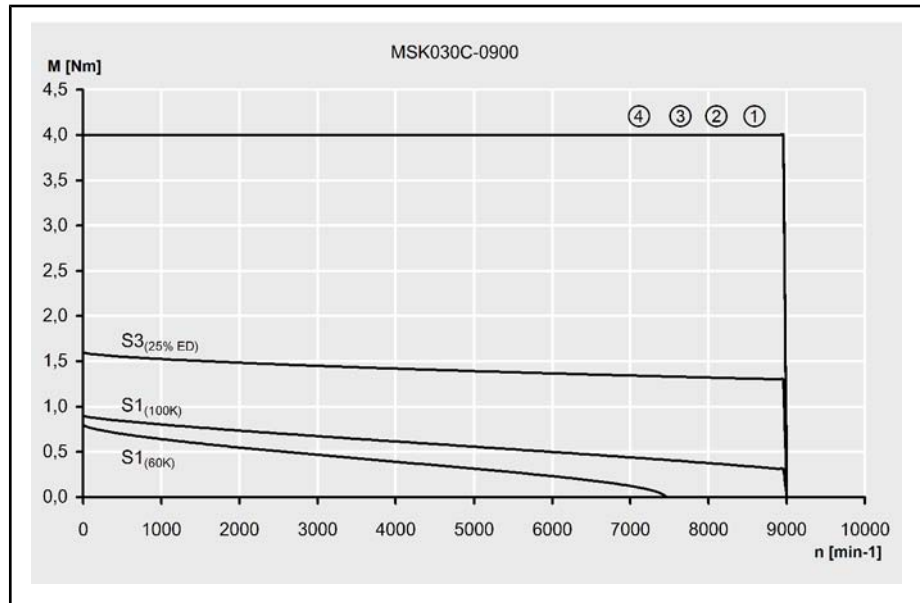

- ① Mmax for IndraDrive, controlled feed, 3x AC 400V
- ② Mmax for IndraDrive, uncontrolled feed, 3x AC 480V
- ③ Mmax for IndraDrive, uncontrolled feed, 3x AC 440V
- ④ Mmax for IndraDrive, uncontrolled feed, 3x AC 400V

Fig.4-10: Speed-torque characteristic of MSK030C-0900

Shaft load

Diagram for determining the maximum permissible radial force F_{radial} .

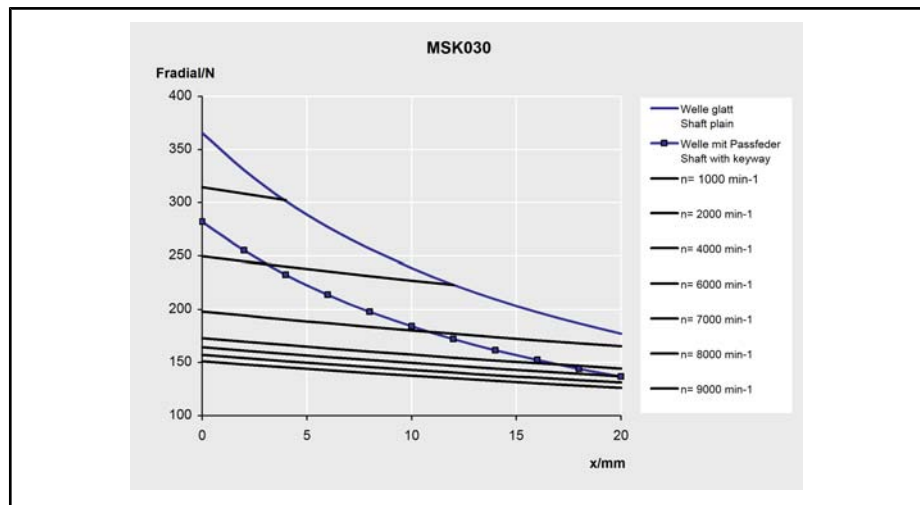

Fig.4-11: permissible radial force of MSK030 - Motors (shaft and bearing load)

The maximum permissible axial force F_{axial} is 50 N.

For additional information about permissible radial and axial forces, see [chapter 9.7 "Bearing and Shaft Load"](#) on page 164.

4.4 MSK040B Technical Data

Description	Symbol	Unit	MSK040B-0600-NN
Continuous torque at standstill, 60K	M_{0_60}	Nm	1,7
Continuous current at standstill, 60K	$I_{0_60(\text{eff})}$	A	2,0
Continuous torque at standstill, 100K	M_{0_100}	Nm	---
Continuous current at standstill, 100K	$I_{0_100(\text{eff})}$	A	---
Maximum torque	M_{max}	Nm	5,1
Maximum current	$I_{\text{max}(\text{eff})}$	A	8,0
Torque constant at 20°C	K_{M_N}	Nm/A	0,95
Constant voltage at 20°C	K_{EMK_1000}	V/min ⁻¹	58,5
Winding resistance at 20°C	R_{12}	Ohm	7,90
Winding inductivity	L_{12}	mH	36,000
Leakage capacitance of the component	C_{ab}	nF	1,5
Number of pole pairs	p	-	4
Moment of inertia of rotor without brake ¹⁾	J_{rot}	kg*m ²	0,00010
Thermal time constant	T_{th}	min	13,0
Maximum speed	n_{max}	min ⁻¹	7500
Sound pressure level	L_p	dB[A]	<75
Ambient temperature during operation	T_{um}	°C	0 ... 40
Degree of protection		-	IP65
Insulation class EN 60034-1		-	F

1) Specified without brake. If necessary, add the moment of inertia brake.
 Fig.4-12: Technical Data

Description	Symbol	Unit	BREMSE-305590
Holding torque	M_4	Nm	4,0
Rated voltage ±10%	U_N	V	24
Rated current	I_N	A	0,50
Connection time	t_1	ms	35
Disconnection time	t_2	ms	25
Moment of inertia brake	J_{rot}	kg*m ²	0,000023
Mass brake	M_{Br}	kg	0,3

Fig.4-13: MSK040: Holding brake - Technical data (optional)

Technical Data

Speed-torque characteristics

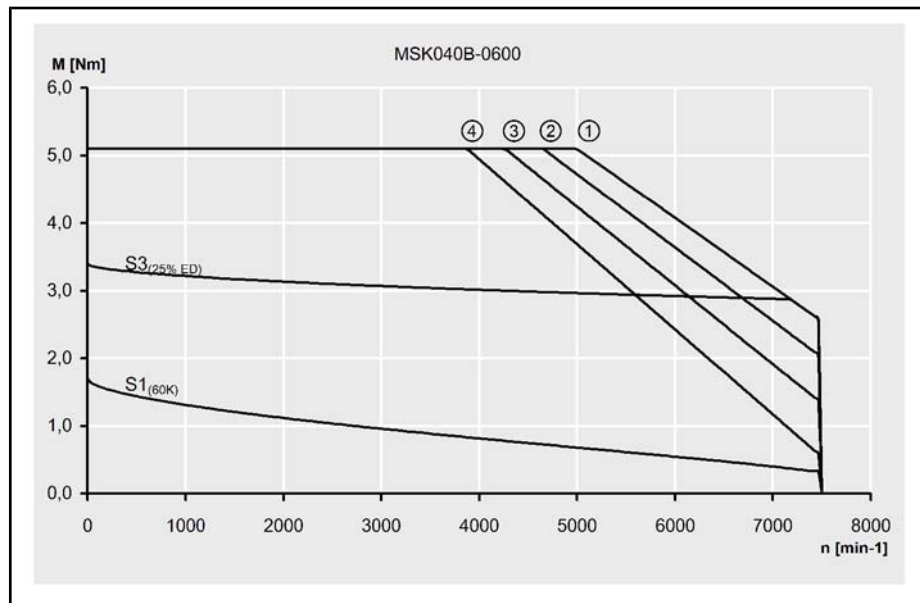

- ① Mmax for IndraDrive, controlled feed, 3x AC 400V
- ② Mmax for IndraDrive, uncontrolled feed, 3x AC 480V
- ③ Mmax for IndraDrive, uncontrolled feed, 3x AC 440V
- ④ Mmax for IndraDrive, uncontrolled feed, 3x AC 400V

Fig.4-14: Speed-torque characteristic of MSK040B-0600

Shaft load

Diagram for determining the maximum permissible radial force F_{radial} .

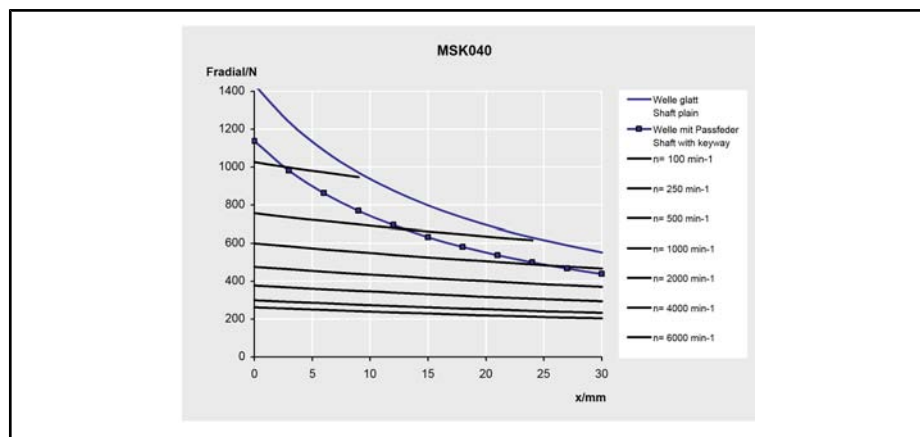

Fig.4-15: permissible radial force of MSK040 - Motors (shaft and bearing load)

The maximum permissible axial force F_{axial} is 200 N.

For additional information about permissible radial and axial forces, see [chapter 9.7 "Bearing and Shaft Load"](#) on page 164.

4.5 MSK040C Technical Data

Description	Symbol	Unit	MSK040C-0600-NN
continuous torque at standstill, 60K	M_{0_60}	Nm	2,7
continuous current at standstill, 60K	$I_{0_60(\text{eff})}$	A	3,1
continuous torque at standstill, 100K	M_{0_100}	Nm	3,1
continuous current at standstill, 100K	$I_{0_100(\text{eff})}$	A	---
maximum torque	M_{max}	Nm	8,1
maximum current	$I_{\text{max}(\text{eff})}$	A	12,4
torque constant at 20°C	K_{M_N}	Nm/A	0,95
constant voltage at 20°C	$K_{\text{EMK_1000}}$	V/min ⁻¹	58,2
winding resistance at 20°C	R_{12}	Ohm	3,90
winding inductivity	L_{12}	mH	21,300
leakage capacitance of the component	C_{ab}	nF	2,0
number of pole pairs	p	-	4
moment of inertia of rotor without brake ¹⁾	J_{rot}	kg*m ²	0,00014
thermal time constant	T_{th}	min	16,0
maximum speed	n_{max}	min ⁻¹	7500
sound pressure level	L_p	dB[A]	<75
ambient temperature during operation	T_{um}	°C	0 ... 40
degree of protection		-	IP65
insulation class EN 60034-1		-	F

1) specified without brake. If necessary, add the moment of inertia brake.
Fig.4-16: MSK - Technical Data (natural cooling)

Description	Symbol	Unit	BREMSE-305590
holding torque	M_4	Nm	4,0
rated voltage ±10%	U_N	V	24
rated current	I_N	A	0,50
connection time	t_1	ms	35
disconnection time	t_2	ms	25
moment of inertia brake	J_{rot}	kg*m ²	0,000023
mass brake	M_{Br}	kg	0,3

Fig.4-17: MSK040: Holding brake - Technical data (optional)

Technical Data

Speed-torque characteristics

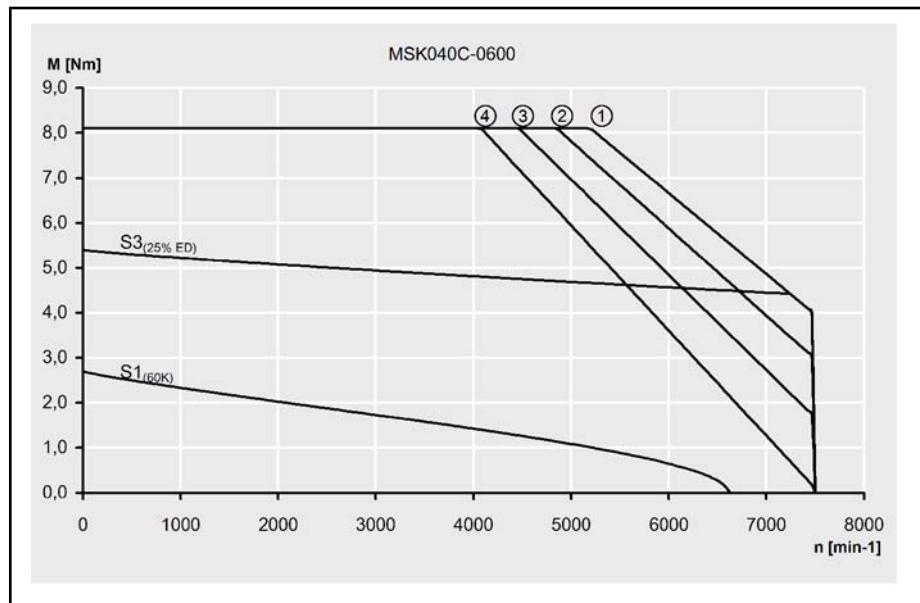

- ① Mmax for IndraDrive, controlled feed, 3x AC 400V
- ② Mmax for IndraDrive, uncontrolled feed, 3x AC 480V
- ③ Mmax for IndraDrive, uncontrolled feed, 3x AC 440V
- ④ Mmax for IndraDrive, uncontrolled feed, 3x AC 400V

Fig.4-18: Speed-torque characteristic of MSK040C-0600

Shaft load

Diagram for determining the maximum permissible radial force F_{radial} .

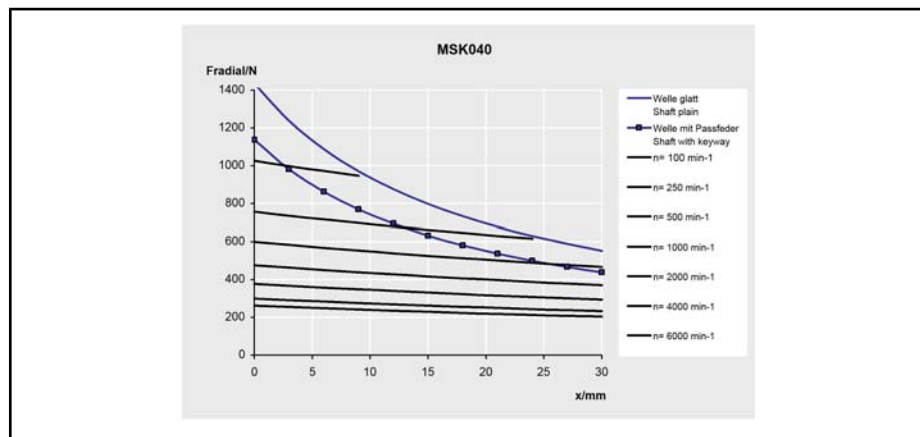

Fig.4-19: permissible radial force of MSK040 - Motors (shaft and bearing load)

The maximum permissible axial force F_{axial} is 200 N.

For additional information about permissible radial and axial forces, see [chapter 9.7 "Bearing and Shaft Load"](#) on page 164.

4.6 MSK050B Technical Data

Description	Symbol	Unit	MSK050B-0300-NN	MSK050B-0600-NN
continuous torque at standstill, 60K	$M_{0,60}$	Nm	3,0	
continuous current at standstill, 60K	$I_{0,60(\text{eff})}$	A	1,8	3,7
continuous torque at standstill, 100K	$M_{0,100}$	Nm	3,4	
continuous current at standstill, 100K	$I_{0,100(\text{eff})}$	A	---	4,2
maximum torque	M_{max}	Nm	9,0	
maximum current	$I_{\text{max}(\text{eff})}$	A	7,2	14,8
torque constant at 20°C	$K_{M,N}$	Nm/A	1,80	0,90
constant voltage at 20°C	K_{EMK_1000}	V/min ⁻¹	111,0	55,0
winding resistance at 20°C	R_{12}	Ohm	13,10	3,30
winding inductivity	L_{12}	mH	76,400	19,900
leakage capacitance of the component	C_{ab}	nF	2,1	
number of pole pairs	p	-	4	
moment of inertia of rotor without brake ¹⁾	J_{rot}	kg*m ²	0,00028	
thermal time constant	T_{th}	min	8,0	
maximum speed	n_{max}	min ⁻¹	4300	6000
sound pressure level	L_p	dB[A]	<75	
ambient temperature during operation	T_{um}	°C	0 ... 40	
degree of protection		-	IP65	
insulation class EN 60034-1		-	F	

1) specified without brake. If necessary, add the moment of inertia brake.
Fig.4-20: MSK - Technical Data (natural cooling)

Description	Symbol	Unit	BREMSE-298905
holding torque	M_4	Nm	5,0
rated voltage ±10%	U_N	V	24
rated current	I_N	A	0,65
connection time	t_1	ms	13
disconnection time	t_2	ms	43
moment of inertia brake	J_{rot}	kg*m ²	0,000107
mass brake	M_{Br}	kg	0,7

Fig.4-21: MSK050: Holding brake - Technical data (optional)

Technical Data

Speed-torque characteristic

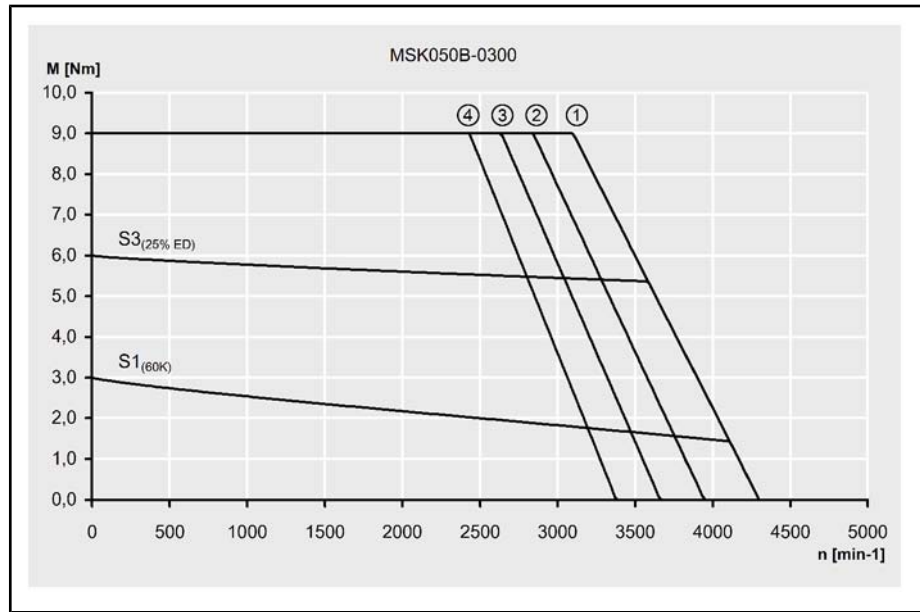

- ① Mmax for IndraDrive, controlled feed, 3x AC 400V
- ② Mmax for IndraDrive, uncontrolled feed, 3x AC 480V
- ③ Mmax for IndraDrive, uncontrolled feed, 3x AC 440V
- ④ Mmax for IndraDrive, uncontrolled feed, 3x AC 400V

Fig.4-22: Speed-torque characteristic of MSK050B-0300

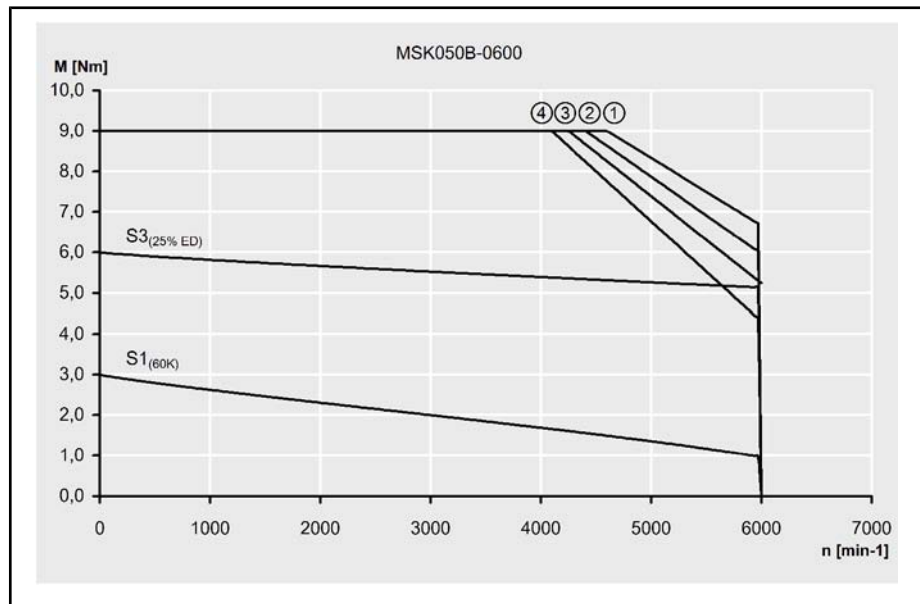

- ① Mmax for IndraDrive, controlled feed, 3x AC 400V
- ② Mmax for IndraDrive, uncontrolled feed, 3x AC 480V
- ③ Mmax for IndraDrive, uncontrolled feed, 3x AC 440V
- ④ Mmax for IndraDrive, uncontrolled feed, 3x AC 400V

Fig.4-23: Speed-torque characteristic of MSK050B-0600

Shaft load Diagram for determining the maximum permissible radial force F_{radial} .

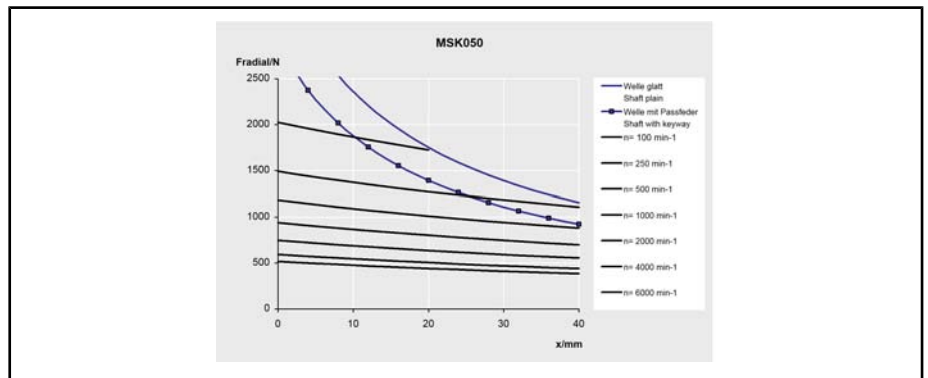

Fig.4-24: permissible radial force of MSK050 - Motors (shaft and bearing load)

The maximum permissible axial force F_{axial} is 300 N.

For additional information about permissible radial and axial forces, see [chapter 9.7 "Bearing and Shaft Load "](#) on page 164.

Technical Data

4.7 MSK050C Technical Data

Description	Symbol	Unit	MSK050C-0300-NN	MSK050C-0600-NN
Continuous torque at standstill, 60K	$M_{0,60}$	Nm	5,0	
Continuous current at standstill, 60K	$I_{0,60(\text{eff})}$	A	3,1	6,2
Continuous torque at standstill, 100K	$M_{0,100}$	Nm	5,5	
Continuous current at standstill, 100K	$I_{0,100(\text{eff})}$	A	---	6,8
Maximum torque	M_{max}	Nm	15,0	
Maximum current	$I_{\text{max}(\text{eff})}$	A	12,4	24,8
Torque constant at 20°C	$K_{M,N}$	Nm/A	1,77	0,89
Constant voltage at 20°C	$K_{EMK,1000}$	V/min ⁻¹	109,0	55,0
Winding resistance at 20°C	R_{12}	Ohm	6,60	1,70
Winding inductivity	L_{12}	mH	46,100	11,000
Leakage capacitance of the component	C_{ab}	nF	2,6	
Number of pole pairs	p	-	4	
Moment of inertia of rotor without brake ¹⁾	J_{rot}	kg*m ²	0,00033	
Thermal time constant	T_{th}	min	14,0	
Maximum speed	n_{max}	min ⁻¹	4700	6000
Sound pressure level	L_P	dB[A]	<75	
Ambient temperature during operation	T_{um}	°C	0 ... 40	
Degree of protection		-	IP65	
Insulation class EN 60034-1		-	F	

1) Specified without brake. If necessary, add the moment of inertia brake.
 Fig.4-25: MSK - Technical Data (natural cooling)

Description	Symbol	Unit	BREMSE-298905
Holding torque	M_4	Nm	5,0
Rated voltage ±10%	U_N	V	24
Rated current	I_N	A	0,65
Connection time	t_1	ms	13
Disconnection time	t_2	ms	43
Moment of inertia brake	J_{rot}	kg*m ²	0,000107
Mass brake	M_{Br}	kg	0,7

Fig.4-26: MSK050: Holding brake - Technical data (optional)

Speed-torque characteristic

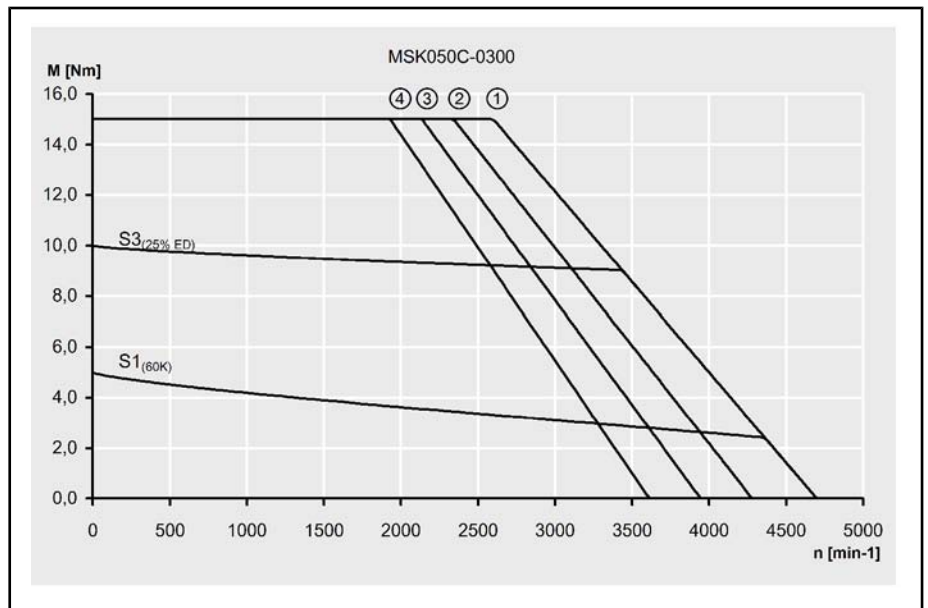

- ① Mmax for IndraDrive, controlled feed, 3x AC 400V
- ② Mmax for IndraDrive, uncontrolled feed, 3x AC 480V
- ③ Mmax for IndraDrive, uncontrolled feed, 3x AC 440V
- ④ Mmax for IndraDrive, uncontrolled feed, 3x AC 400V

Fig.4-27: Speed-torque characteristic of MSK050C-0300

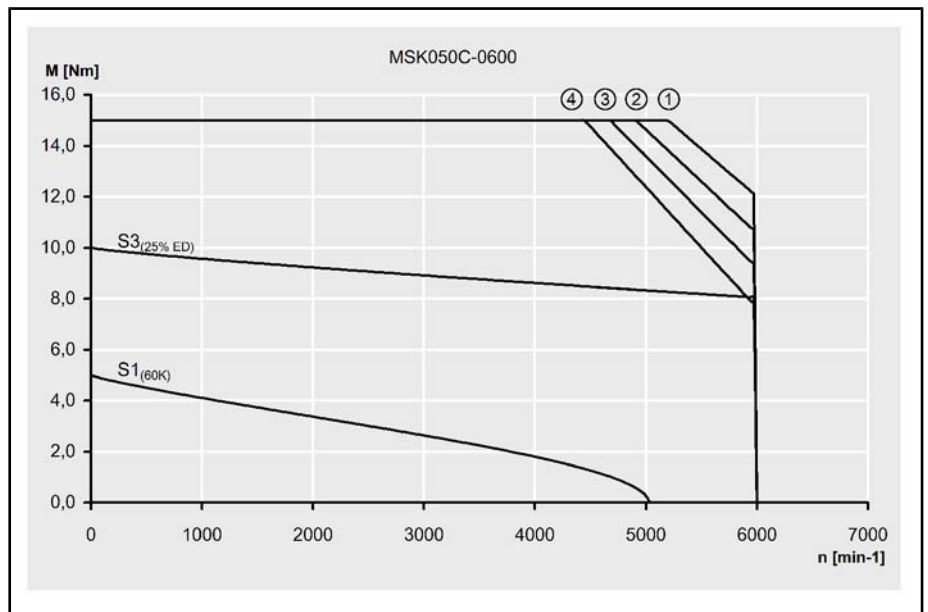

- ① Mmax for IndraDrive, controlled feed, 3x AC 400V
- ② Mmax for IndraDrive, uncontrolled feed, 3x AC 480V
- ③ Mmax for IndraDrive, uncontrolled feed, 3x AC 440V
- ④ Mmax for IndraDrive, uncontrolled feed, 3x AC 400V

Fig.4-28: Speed-torque characteristic of MSK050C-0600

Technical Data

Shaft load Diagram for determining the maximum permissible radial force F_{radial} .

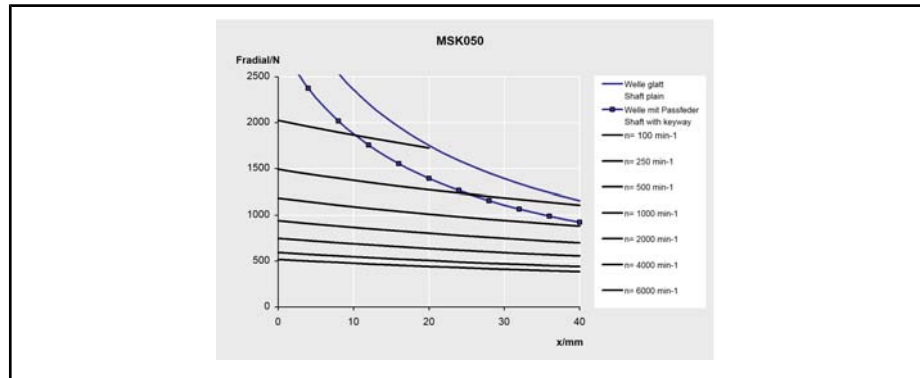

Fig.4-29: permissible radial force of MSK050 - Motors (shaft and bearing load)

The maximum permissible axial force F_{axial} is 300 N.

For additional information about permissible radial and axial forces, see [chapter 9.7 "Bearing and Shaft Load "](#) on page 164.

4.8 MSK060B Technical Data

Description	Symbol	Unit	MSK060B-0300-NN	MSK060B-0600-NN
Continuous torque at standstill, 60K	M_{0_60}	Nm	5,0	
Continuous current at standstill, 60K	$I_{0_60(\text{eff})}$	A	3,0	6,1
Continuous torque at standstill, 100K	M_{0_100}	Nm	---	
Continuous current at standstill, 100K	$I_{0_100(\text{eff})}$	A	---	
Maximum torque	M_{max}	Nm	15,0	
Maximum current	$I_{\text{max}(\text{eff})}$	A	12,0	24,4
Torque constant at 20°C	K_{M_N}	Nm/A	1,85	0,90
Constant voltage at 20°C	K_{EMK_1000}	V/min ⁻¹	113,5	55,2
Winding resistance at 20°C	R_{12}	Ohm	7,30	1,85
Winding inductivity	L_{12}	mH	73,000	18,000
Leakage capacitance of the component	C_{ab}	nF	2,1	
Number of pole pairs	p	-	4	
Moment of inertia of rotor without brake ¹⁾	J_{rot}	kg*m ²	0,00048	
Thermal time constant	T_{th}	min	16,0	
Maximum speed	n_{max}	min ⁻¹	4800	6000
Sound pressure level	L_p	dB[A]	<75	
Ambient temperature during operation	T_{um}	°C	0 ... 40	
Degree of protection		-	IP65	
Insulation class EN 60034-1		-	F	

1) Specified without brake. If necessary, add the moment of inertia brake.
Fig.4-30: MSK - Technical Data (natural cooling)

Description	Symbol	Unit	BREMSE-299026
Holding torque	M_4	Nm	10,0
Rated voltage ±10%	U_N	V	24
Rated current	I_N	A	0,75
Connection time	t_1	ms	25
Disconnection time	t_2	ms	40
Moment of inertia brake	J_{rot}	kg*m ²	0,000059
Mass brake	M_{Br}	kg	0,4

Fig.4-31: MSK060: Holding brake - Technical data (optional)

Technical Data

Speed-torque characteristics

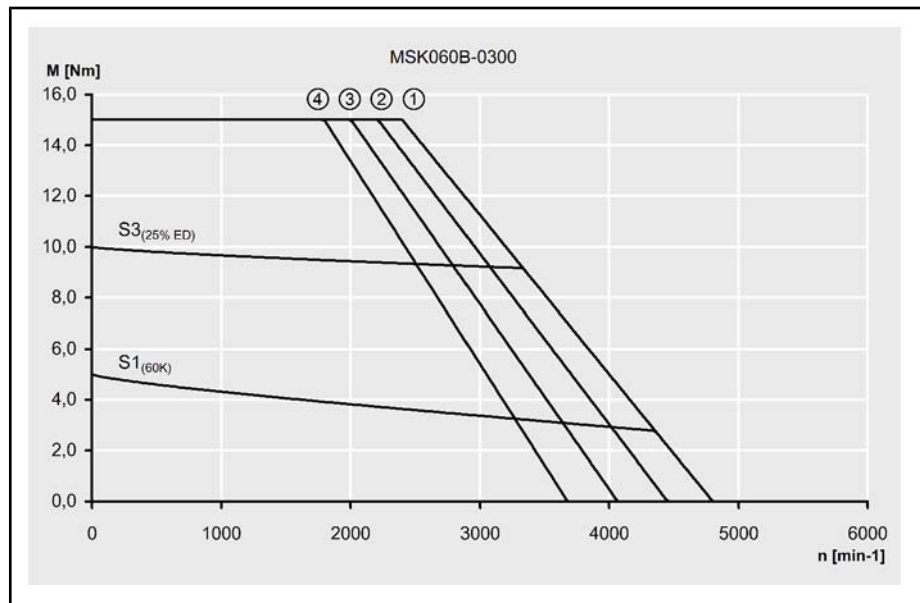

- ① Mmax for IndraDrive, controlled feed, 3x AC 400V
- ② Mmax for IndraDrive, uncontrolled feed, 3x AC 480V
- ③ Mmax for IndraDrive, uncontrolled feed, 3x AC 440V
- ④ Mmax for IndraDrive, uncontrolled feed, 3x AC 400V

Fig.4-32: Speed-torque characteristic of MSK060B-0300

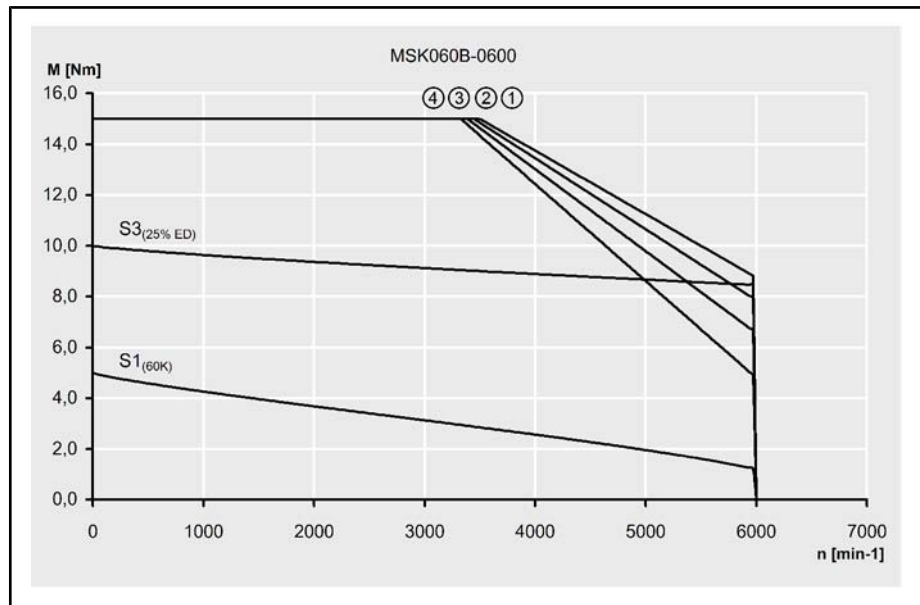

- ① Mmax for IndraDrive, controlled feed, 3x AC 400V
- ② Mmax for IndraDrive, uncontrolled feed, 3x AC 480V
- ③ Mmax for IndraDrive, uncontrolled feed, 3x AC 440V
- ④ Mmax for IndraDrive, uncontrolled feed, 3x AC 400V

Fig.4-33: Speed-torque characteristic of MSK060B-0600

Shaft load Diagram for determining the maximum permissible radial force F_{radial} .

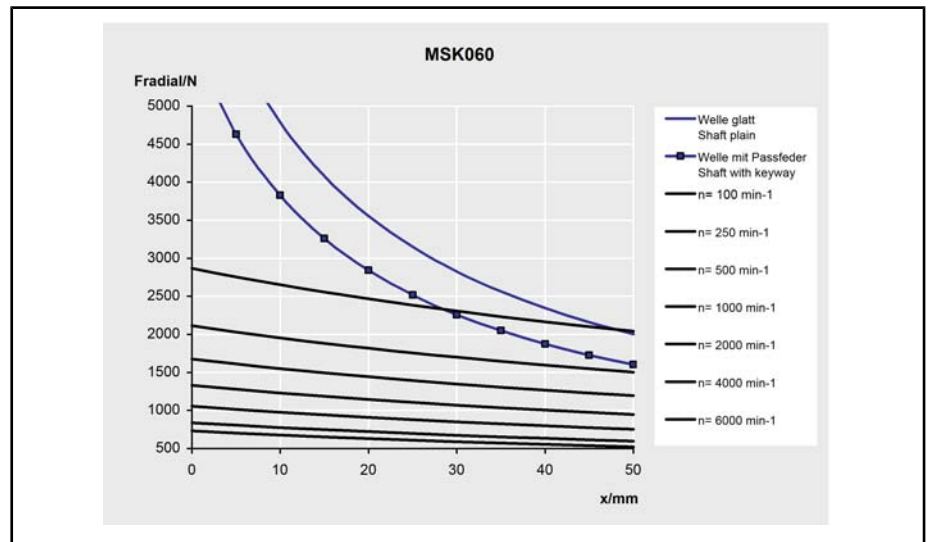

Fig.4-34: permissible radial force of MSK060 - Motors (shaft and bearing load)

The maximum permissible axial force F_{axial} is 350 N.

For additional information about permissible radial and axial forces, see [chapter 9.7 "Bearing and Shaft Load"](#) on page 164.

Technical Data

4.9 MSK060C Technical Data

Description	Symbol	Unit	MSK060C-0300-NN	MSK060C-0600-NN
Continuous torque at standstill, 60K	$M_{0,60}$	Nm	8,0	
Continuous current at standstill, 60K	$I_{0,60(\text{eff})}$	A	4,8	9,5
Continuous torque at standstill, 100K	$M_{0,100}$	Nm	8,8	
Continuous current at standstill, 100K	$I_{0,100(\text{eff})}$	A	5,5	10,5
Continuous torque at standstill, surface	$M_{0,S}$	Nm	10,4	
Continuous current at standstill, surface	$I_{0,S(\text{eff})}$	A	6,2	---
Maximum torque	M_{max}	Nm	24,0	
Maximum current	$I_{\text{max}(\text{eff})}$	A	19,2	38,0
Torque constant at 20°C	$K_{M,N}$	Nm/A	1,85	0,93
Constant voltage at 20°C	$K_{EMK,1000}$	V/min ⁻¹	114,0	57,0
Winding resistance at 20°C	R_{12}	Ohm	3,10	0,80
Winding inductivity	L_{12}	mH	35,900	8,600
Leakage capacitance of the component	C_{ab}	nF	2,1	2,2
Number of pole pairs	p	-	4	
Moment of inertia of rotor without brake ¹⁾	J_{rot}	kg*m ²	0,00080	
Thermal time constant	T_{th}	min	14,0	
Maximum speed	n_{max}	min ⁻¹	4900	6000
Sound pressure level	L_p	dB[A]	<75	
Ambient temperature during operation	T_{um}	°C	0 ... 40	
Degree of protection		-	IP65	
Insulation class EN 60034-1		-	F	

1) Specified without brake. If necessary, add the moment of inertia brake.
 Fig.4-35: MSK - Technical Data (natural and surface cooling)

Description	Symbol	Unit	BREMSE-299026
Holding torque	M_4	Nm	10,0
Rated voltage ±10%	U_N	V	24
Rated current	I_N	A	0,75
Connection time	t_1	ms	25

Description	Symbol	Unit	BREMSE-299026
Disconnection time	t_2	ms	40
Moment of inertia brake	J_{rot}	kg*m2	0,000059
Mass brake	M_{Br}	kg	0,4

Fig.4-36: MSK060: Holding brake - Technical data (optional)

Speed-torque characteristic

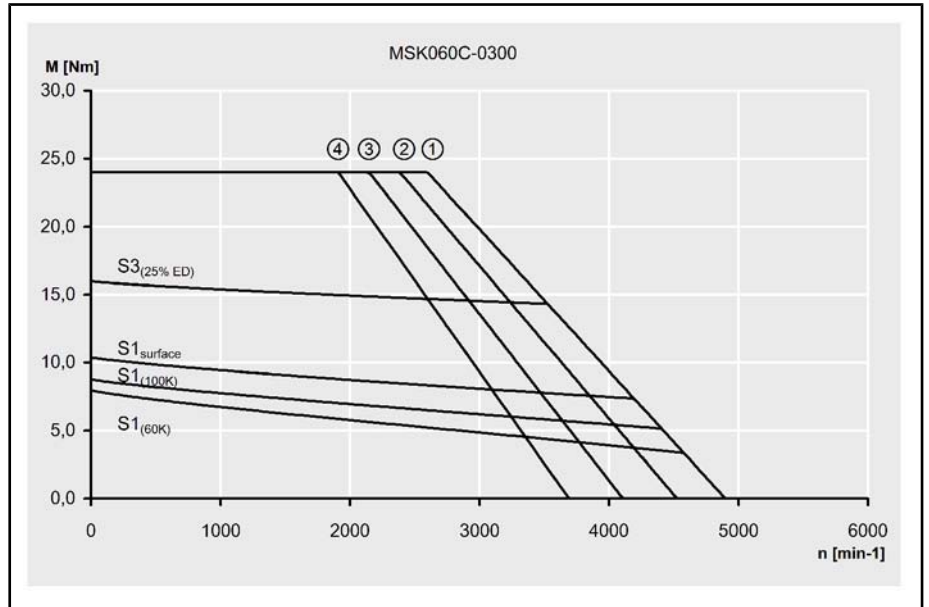

- ① Mmax for IndraDrive, controlled feed, 3x AC 400V
- ② Mmax for IndraDrive, uncontrolled feed, 3x AC 480V
- ③ Mmax for IndraDrive, uncontrolled feed, 3x AC 440V
- ④ Mmax for IndraDrive, uncontrolled feed, 3x AC 400V

Fig.4-37: Speed-torque characteristic of MSK060C-0300

Technical Data

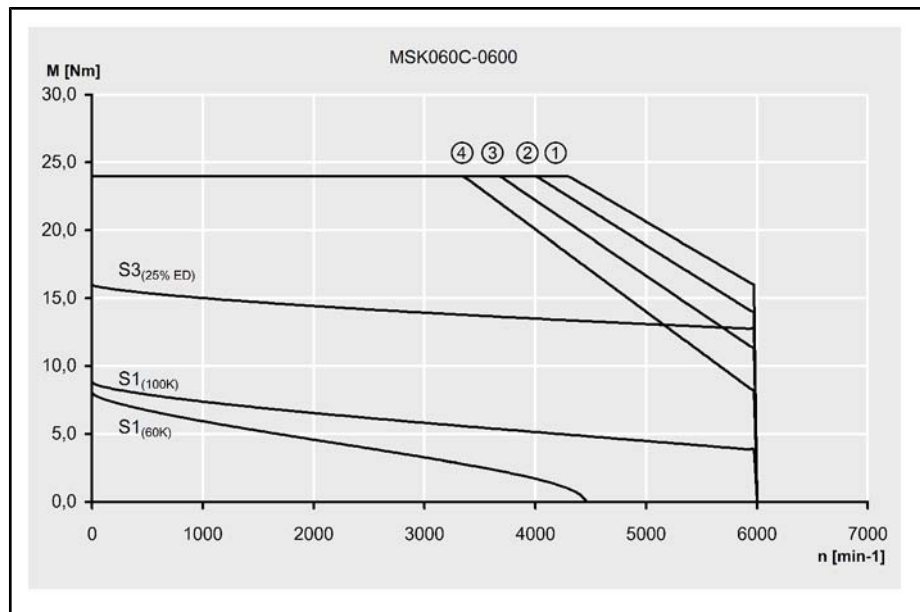

- ① Mmax for IndraDrive, controlled feed, 3x AC 400V
- ② Mmax for IndraDrive, uncontrolled feed, 3x AC 480V
- ③ Mmax for IndraDrive, uncontrolled feed, 3x AC 440V
- ④ Mmax for IndraDrive, uncontrolled feed, 3x AC 400V

Fig.4-38: Speed-torque characteristic of MSK060C-0600

Shaft load Diagram for determining the maximum permissible radial force F_{radial} .

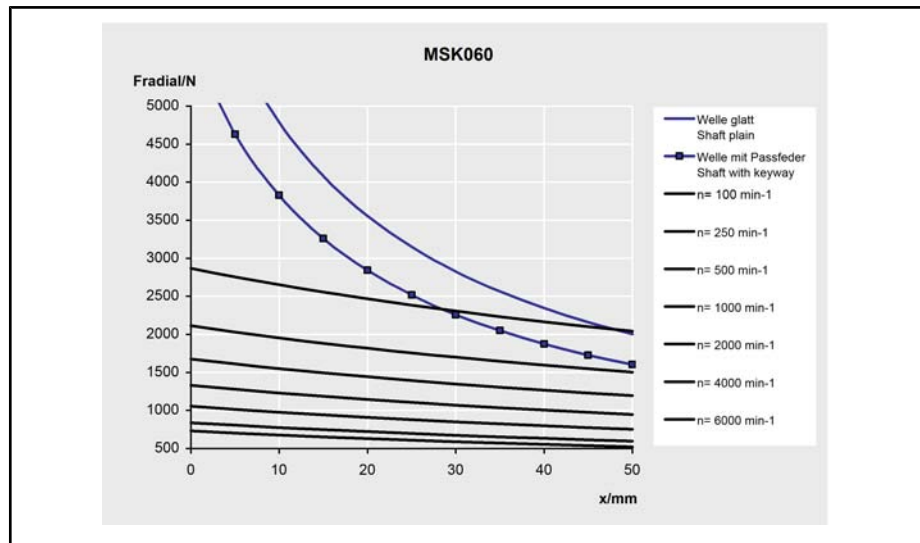

Fig.4-39: permissible radial force of MSK060 - Motors (shaft and bearing load)

The maximum permissible axial force F_{axial} is **350 N**.

For additional information about permissible radial and axial forces, see [chapter 9.7 "Bearing and Shaft Load "](#) on page 164.

4.10 MSK061C Technical Data

Description	Symbol	Unit	MSK061C-0600-NN
Continuous torque at standstill, 60K	M_{0_60}	Nm	8,0
Continuous current at standstill, 60K	$I_{0_60(\text{eff})}$	A	7,7
Continuous torque at standstill, 100K	M_{0_100}		
Continuous current at standstill, 100K	$I_{0_100(\text{eff})}$		
Maximum torque	M_{max}	Nm	32,0
Maximum current	$I_{\text{max}(\text{eff})}$	A	34,7
Torque constant at 20°C	K_{M_N}	Nm/A	1,14
Constant voltage at 20°C	K_{EMK_1000}	V/min ⁻¹	70,5
Winding resistance at 20°C	R_{12}	Ohm	1,55
Winding inductivity	L_{12}	mH	6,700
Leakage capacitance of the component	C_{ab}	nF	2,1
Number of pole pairs	p	-	4
Moment of inertia of rotor without brake ¹⁾	J_{rot}	kg*m ²	0,00075
Thermal time constant	T_{th}	min	15,0
Maximum speed	n_{max}	min ⁻¹	6000
Sound pressure level	L_p	dB[A]	<75
Ambient temperature during operation	T_{um}	°C	0 ... 40
Degree of protection		-	IP 65
Insulation class EN 60034-1		-	F

1) Specified without brake. If necessary, add the moment of inertia brake.
Fig.4-40: MSK - Technical Data (natural cooling)

Description	Symbol	Unit	BREMSE-299026
holding torque	M_4	Nm	10,0
rated voltage ±10%	U_N	V	24
rated current	I_N	A	0,75
connection time	t_1	ms	25
disconnection time	t_2	ms	40
moment of inertia brake	J_{rot}	kg*m ²	0,000059
mass brake	M_{Br}	kg	0,4

Fig.4-41: MSK061: Holding brake - Technical data (optional)

Technical Data

Speed-torque characteristics

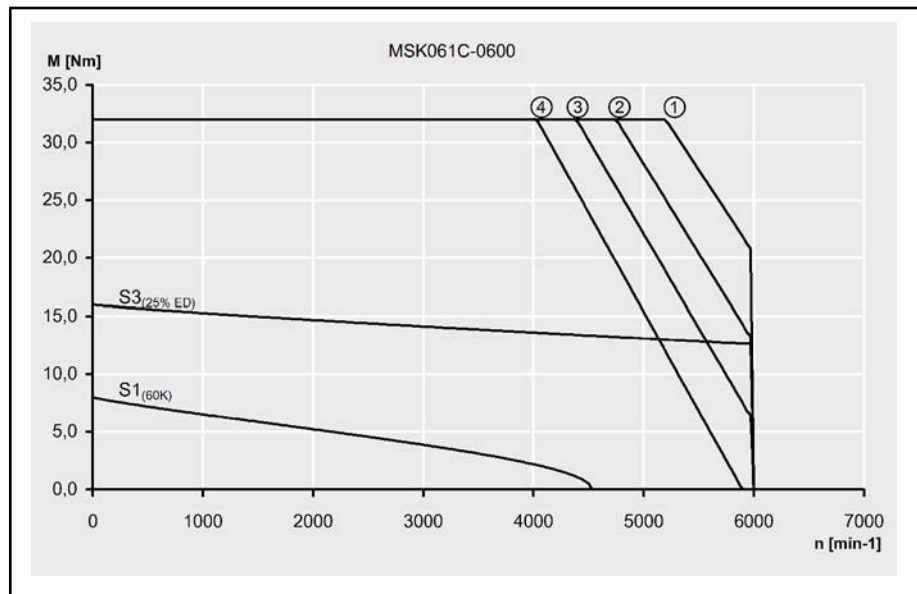

- ① Mmax for IndraDrive, controlled feed, 3x AC 400V
- ② Mmax for IndraDrive, uncontrolled feed, 3x AC 480V
- ③ Mmax for IndraDrive, uncontrolled feed, 3x AC 440V
- ④ Mmax for IndraDrive, uncontrolled feed, 3x AC 400V

Fig.4-42: Speed-torque characteristic of MSK061C-0600

Shaft load Diagram for determining the maximum permissible radial force F_{radial} .

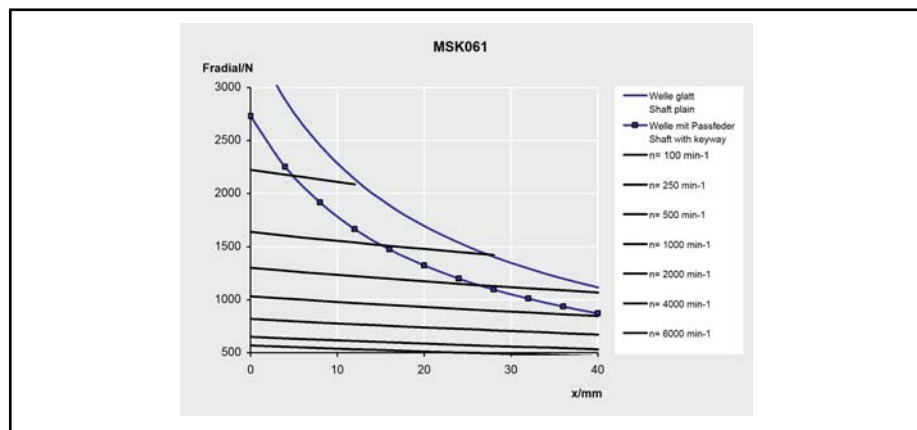

Fig.4-43: permissible radial force of MSK061 - Motors (shaft and bearing load)

The maximum permissible axial force F_{axial} is **250 N**.

For additional information about permissible radial and axial forces, see [chapter 9.7 "Bearing and Shaft Load"](#) on page 164.

4.11 MSK070C Technical Data

Description	Symbol	Unit	MSK070C-0150-NN	MSK070C-0300-NN	MSK070C-0450-NN
Continuous torque at standstill, 60K	M_{0_60}	Nm	13,0		
Continuous current at standstill, 60K	$I_{0_60(\text{eff})}$	A	4,1	8,2	12,3
Continuous torque at standstill, 100K	M_{0_100}	Nm	14,5		
Continuous current at standstill, 100K	$I_{0_100(\text{eff})}$	A	4,6	9,2	13,7
Continuous torque at standstill, surface	M_{0_S}	Nm	19,5		
Continuous current at standstill, surface	$I_{0_S(\text{eff})}$	A	6,2	12,3	18,5
Maximum torque	M_{max}	Nm	33,0		
Maximum current	$I_{\text{max}(\text{eff})}$	A	16,4	32,8	36,9
Torque constant at 20°C	K_{M_N}	Nm/A	3,47	1,74	1,16
Constant voltage at 20°C	K_{EMK_1000}	V/min ⁻¹	213,2	107,0	71,3
Winding resistance at 20°C	R_{12}	Ohm	4,70	1,13	0,55
Winding inductivity	L_{12}	mH	34,900	8,300	4,000
Leakage capacitance of the component	C_{ab}	nF	3,8	4,0	3,1
Number of pole pairs	p	-	6		
Moment of inertia of rotor without brake ¹⁾	J_{rot}	kg*m ²	0,00291		
Thermal time constant	T_{th}	min	22,0		31,0
Maximum speed	n_{max}	min ⁻¹	2500	5500	6000
Sound pressure level	L_p	dB[A]	<75	< 75	<75
Ambient temperature during operation	T_{um}	°C	0 ... 40		
Degree of protection		-	IP65		
Insulation class EN 60034-1		-	F		

1) Specified without brake. If necessary, add the moment of inertia brake.
Fig.4-44: MSK - Technical Data (natural and surface cooling)

Description	Symbol	Unit	BREMSE-298397
Holding torque	M_4	Nm	23,0
Rated voltage ±10%	U_N	V	24
Rated current	I_N	A	0,79
Connection time	t_1	ms	130

Technical Data

Description	Symbol	Unit	BREMSE-298397
Disconnection time	t_2	ms	180
Moment of inertia brake	J_{rot}	kg*m ²	0,000300
Mass brake	M_{Br}	kg	1,6

Fig.4-45: MSK070: Holding brake - Technical data (optional)

Speed-torque characteristics

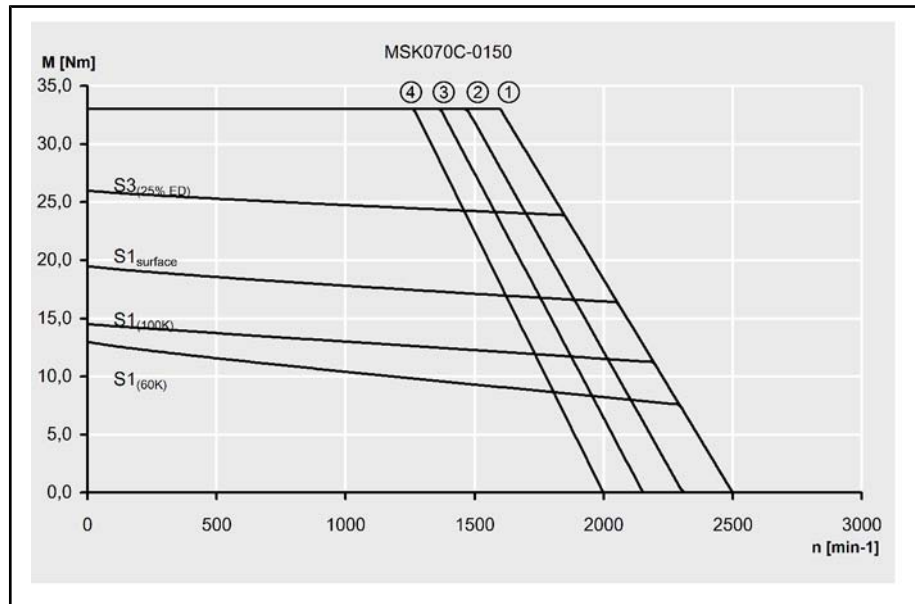

- ① Mmax for IndraDrive, controlled feed, 3x AC 400V
- ② Mmax for IndraDrive, uncontrolled feed, 3x AC 480V
- ③ Mmax for IndraDrive, uncontrolled feed, 3x AC 440V
- ④ Mmax for IndraDrive, uncontrolled feed, 3x AC 400V

Fig.4-46: Speed-torque characteristic of MSK070C-0150

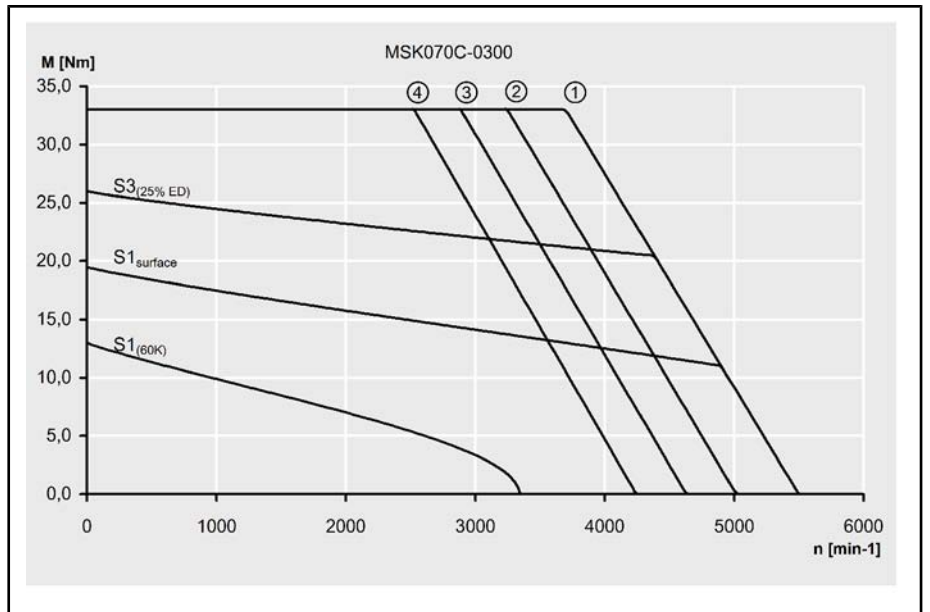

- ① Mmax for IndraDrive, controlled feed, 3x AC 400V
- ② Mmax for IndraDrive, uncontrolled feed, 3x AC 480V
- ③ Mmax for IndraDrive, uncontrolled feed, 3x AC 440V
- ④ Mmax for IndraDrive, uncontrolled feed, 3x AC 400V

Fig.4-47: Speed-torque characteristic of MSK070C-0300

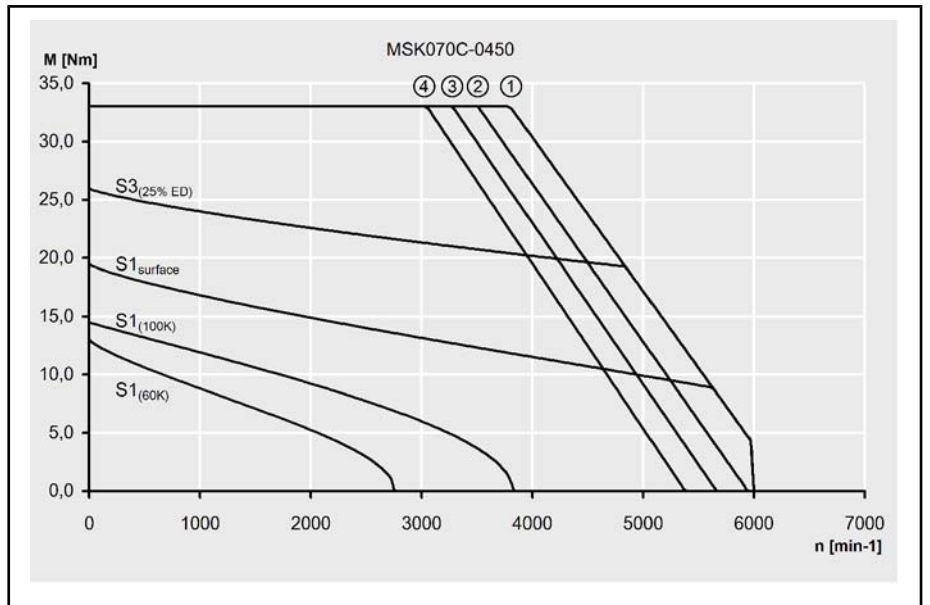

- ① Mmax for IndraDrive, controlled feed, 3x AC 400V
- ② Mmax for IndraDrive, uncontrolled feed, 3x AC 480V
- ③ Mmax for IndraDrive, uncontrolled feed, 3x AC 440V
- ④ Mmax for IndraDrive, uncontrolled feed, 3x AC 400V

Fig.4-48: Speed-torque characteristic of MSK070C-0450

Technical Data

Shaft load Diagram for determining the maximum permissible radial force F_{radial} .

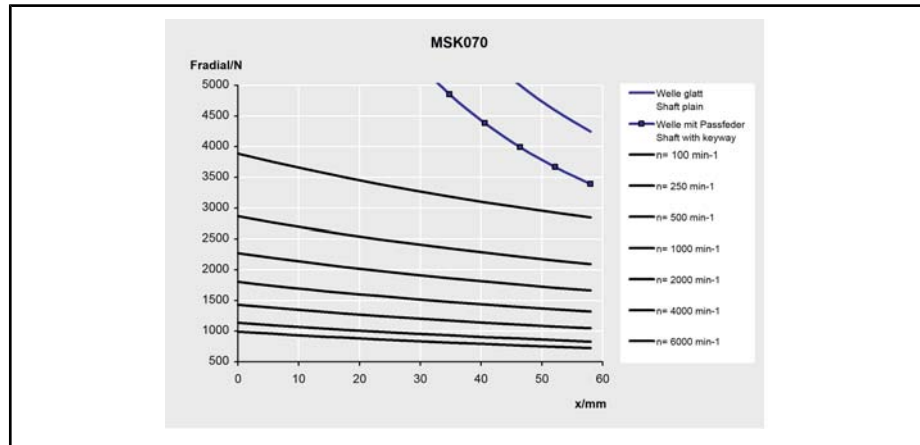

Fig.4-49: permissible radial force of MSK070 - Motors (shaft and bearing load)

The maximum permissible axial force F_{axial} is 500 N.

For additional information about permissible radial and axial forces, see [chapter 9.7 "Bearing and Shaft Load "](#) on page 164.

4.12 MSK070D Technical Data

Description	Symbol	Unit	MSK070D-0150-NN	MSK070D-0300-NN	MSK070D-0450-NN
Continuous torque at standstill, 60K	$M_{0,60}$	Nm	17,5		
Continuous current at standstill, 60K	$I_{0,60(\text{eff})}$	A	6,2	11,0	16,6
Continuous torque at standstill, 100K	$M_{0,100}$	Nm	20,0		
Continuous current at standstill, 100K	$I_{0,100(\text{eff})}$	A	7,1	12,6	22,0
Continuous torque at standstill, surface	$M_{0,S}$	Nm	26,3		
Continuous current at standstill, surface	$I_{0,S(\text{eff})}$	A	9,3	16,5	24,9
Maximum torque	M_{max}	Nm	52,5		
Maximum current	$I_{\text{max}(\text{eff})}$	A	24,8	33,0	49,8
Torque constant at 20°C	$K_{M,N}$	Nm/A	3,10	1,75	1,16
Constant voltage at 20°C	$K_{EMK,1000}$	V/min ⁻¹	210,0	107,3	71,1
Winding resistance at 20°C	R_{12}	Ohm	3,20	0,75	0,37
Winding inductivity	L_{12}	mH	25,900	6,000	3,000
Leakage capacitance of the component	C_{ab}	nF	5,0	4,5	
Number of pole pairs	p	-	6		
Moment of inertia of rotor without brake ¹⁾	J_{rot}	kg*m ²	0,00375		
Thermal time constant	T_{th}	min	23,0		
Maximum speed	n_{max}	min ⁻¹	2700	4900	6000
Sound pressure level	L_p	dB[A]	< 75	<75	
Ambient temperature during operation	T_{um}	°C	0 ... 40		
Degree of protection		-	IP65		
Insulation class EN 60034-1		-	F		

1) Specified without brake. If necessary, add the moment of inertia brake.
Fig.4-50: MSK - Technical Data (natural and surface cooling)

Description	Symbol	Unit	BREMSE-298397
Holding torque	M_4	Nm	23,0
Rated voltage ±10%	U_N	V	24
Rated current	I_N	A	0,79
Connection time	t_1	ms	130

Technical Data

Description	Symbol	Unit	BREMSE-298397
Disconnection time	t_2	ms	180
Moment of inertia brake	J_{rot}	kg*m ²	0,000300
Mass brake	M_{Br}	kg	1,6

Fig.4-51: MSK070: Holding brake - Technical data (optional)

Speed-torque characteristics

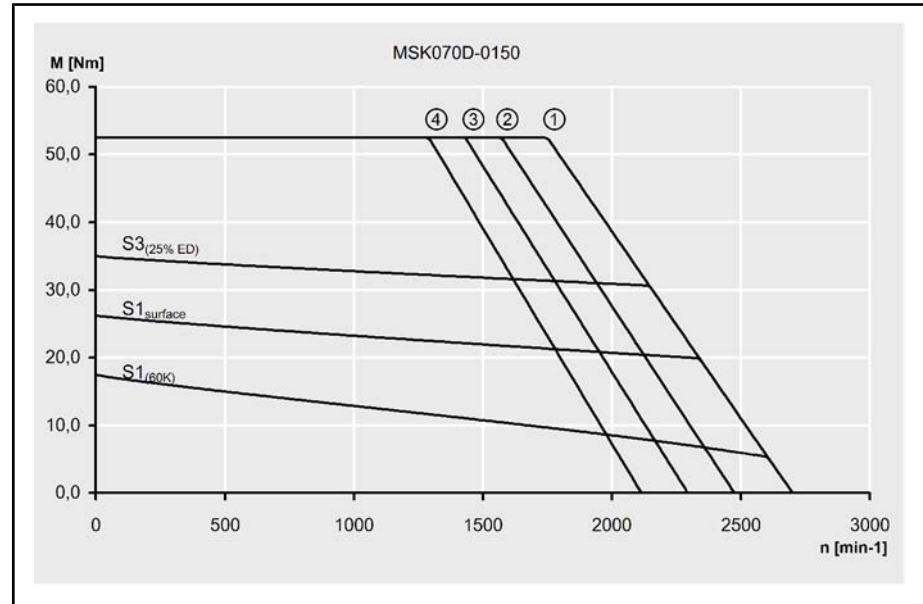

- ① Mmax for IndraDrive, controlled feed, 3x AC 400V
- ② Mmax for IndraDrive, uncontrolled feed, 3x AC 480V
- ③ Mmax for IndraDrive, uncontrolled feed, 3x AC 440V
- ④ Mmax for IndraDrive, uncontrolled feed, 3x AC 400V

Fig.4-52: Speed-torque characteristic of MSK070D-0150

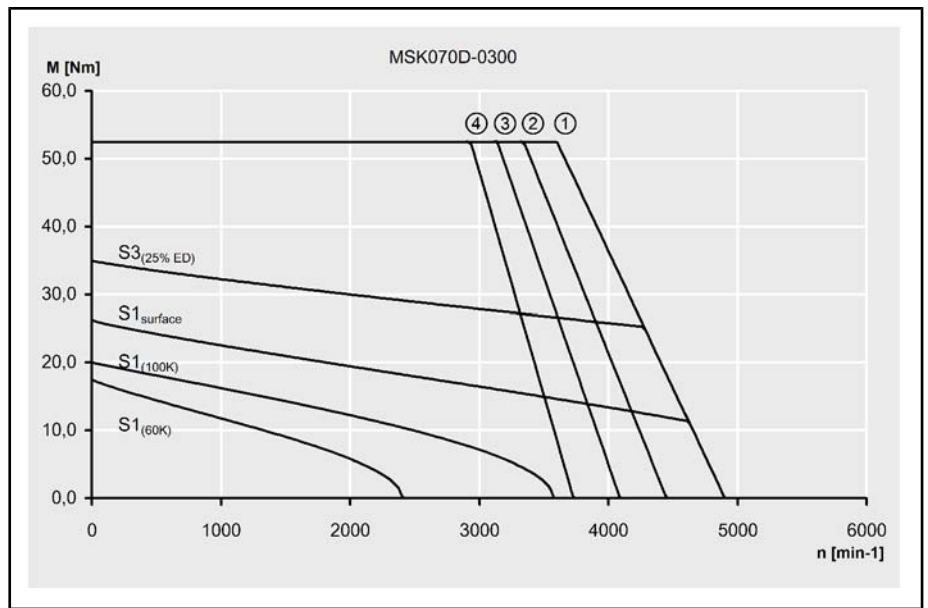

- ① Mmax for IndraDrive, controlled feed, 3x AC 400V
- ② Mmax for IndraDrive, uncontrolled feed, 3x AC 480V
- ③ Mmax for IndraDrive, uncontrolled feed, 3x AC 440V
- ④ Mmax for IndraDrive, uncontrolled feed, 3x AC 400V

Fig.4-53: Speed-torque characteristic of MSK070D-0300

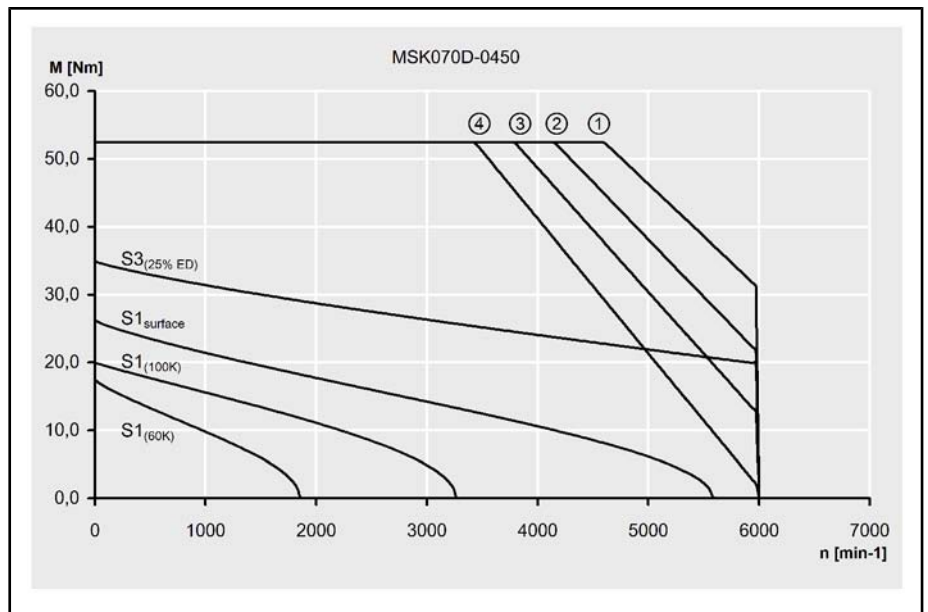

- ① Mmax for IndraDrive, controlled feed, 3x AC 400V
- ② Mmax for IndraDrive, uncontrolled feed, 3x AC 480V
- ③ Mmax for IndraDrive, uncontrolled feed, 3x AC 440V
- ④ Mmax for IndraDrive, uncontrolled feed, 3x AC 400V

Fig.4-54: Speed-torque characteristic of MSK070D-0450

Technical Data

Shaft load Diagram for determining the maximum permissible radial force F_{radial} .

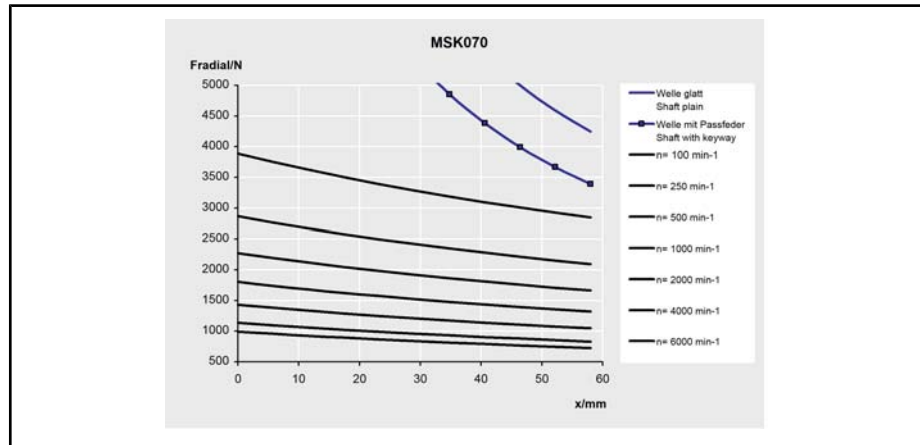

Fig.4-55: permissible radial force of MSK070 - Motors (shaft and bearing load)

The maximum permissible axial force F_{axial} is 500 N.

For additional information about permissible radial and axial forces, see [chapter 9.7 "Bearing and Shaft Load "](#) on page 164.

4.13 MSK070E Technical Data

Description	Symbol	Unit	MSK070E-0150-NN	MSK070E-0300-NN	MSK070E-0450-NN
Continuous torque at standstill, 60K	$M_{0,60}$	Nm	23,0		
Continuous current at standstill, 60K	$I_{0,60(\text{eff})}$	A	6,4	15,4	19,3
Continuous torque at standstill, 100K	$M_{0,100}$	Nm	25,0		
Continuous current at standstill, 100K	$I_{0,100(\text{eff})}$	A	7,0	16,7	---
Continuous torque at standstill, surface	$M_{0,S}$	Nm	34,5		
Continuous current at standstill, surface	$I_{0,S(\text{eff})}$	A	9,6	23,1	29,0
Maximum torque	M_{max}	Nm	70,0	65,0	60,0
Maximum current	$I_{\text{max}(\text{eff})}$	A	25,6	49,3	57,9
Torque constant at 20°C	$K_{M,N}$	Nm/A	3,94	1,64	1,31
Constant voltage at 20°C	K_{EMK_1000}	V/min ⁻¹	242,4	101,0	80,6
Winding resistance at 20°C	R_{12}	Ohm	3,10	0,55	0,36
Winding inductivity	L_{12}	mH	24,500	3,900	2,700
Leakage capacitance of the component	C_{ab}	nF	6,3	3,5	6,7
Number of pole pairs	p	-	6		
Moment of inertia of rotor without brake ¹⁾	J_{rot}	kg*m ²	0,00458		
Thermal time constant	T_{th}	min	75,0	32,0	
Maximum speed	n_{max}	min ⁻¹	2200	5300	6000
Sound pressure level	L_p	dB[A]	<75		
Ambient temperature during operation	T_{um}	°C	0 ... 40		
Degree of protection		-	IP65		
Insulation class EN 60034-1		-	F		

1) Specified without brake. If necessary, add the moment of inertia brake.
Fig.4-56: MSK - Technical Data (natural and surface cooling)

Description	Symbol	Unit	BREMSE-298397
Holding torque	M_4	Nm	23,0
Rated voltage ±10%	U_N	V	24
Rated current	I_N	A	0,79
Connection time	t_1	ms	130

Technical Data

Description	Symbol	Unit	BREMSE-298397
Disconnection time	t_2	ms	180
Moment of inertia brake	J_{rot}	kg*m ²	0,000300
Mass brake	M_{Br}	kg	1,6

Fig.4-57: MSK070: Holding brake - Technical data (optional)

Speed-torque characteristics

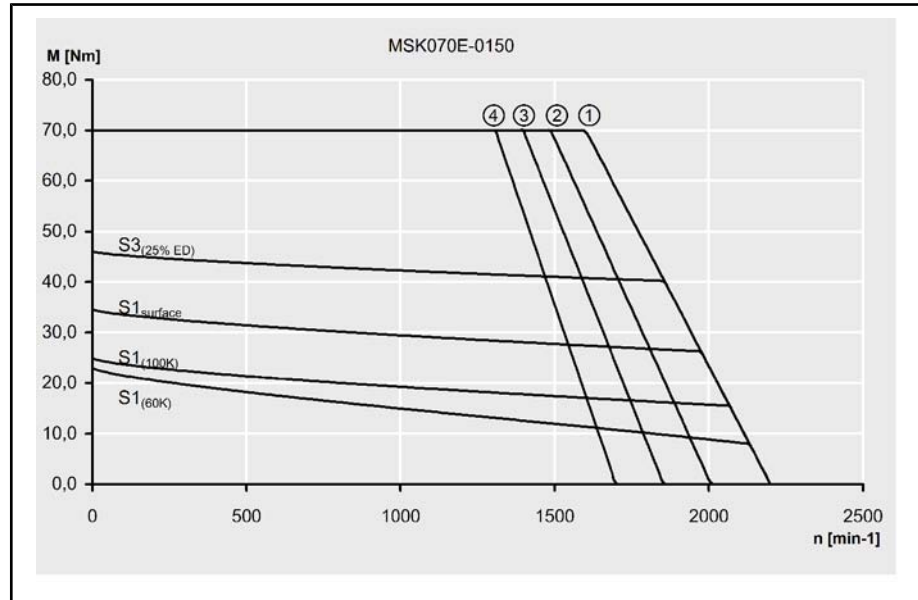

- ① Mmax for IndraDrive, controlled feed, 3x AC 400V
- ② Mmax for IndraDrive, uncontrolled feed, 3x AC 480V
- ③ Mmax for IndraDrive, uncontrolled feed, 3x AC 440V
- ④ Mmax for IndraDrive, uncontrolled feed, 3x AC 400V

Fig.4-58: Speed-torque characteristic of MSK070E-0150

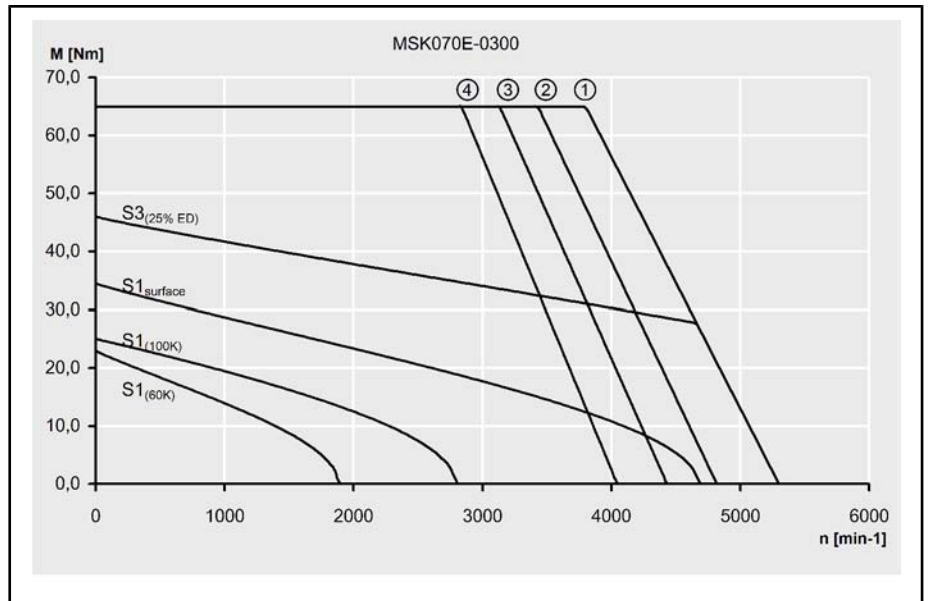

- ① Mmax for IndraDrive, controlled feed, 3x AC 400V
- ② Mmax for IndraDrive, uncontrolled feed, 3x AC 480V
- ③ Mmax for IndraDrive, uncontrolled feed, 3x AC 440V
- ④ Mmax for IndraDrive, uncontrolled feed, 3x AC 400V

Fig.4-59: Speed-torque characteristic of MSK070E-0300

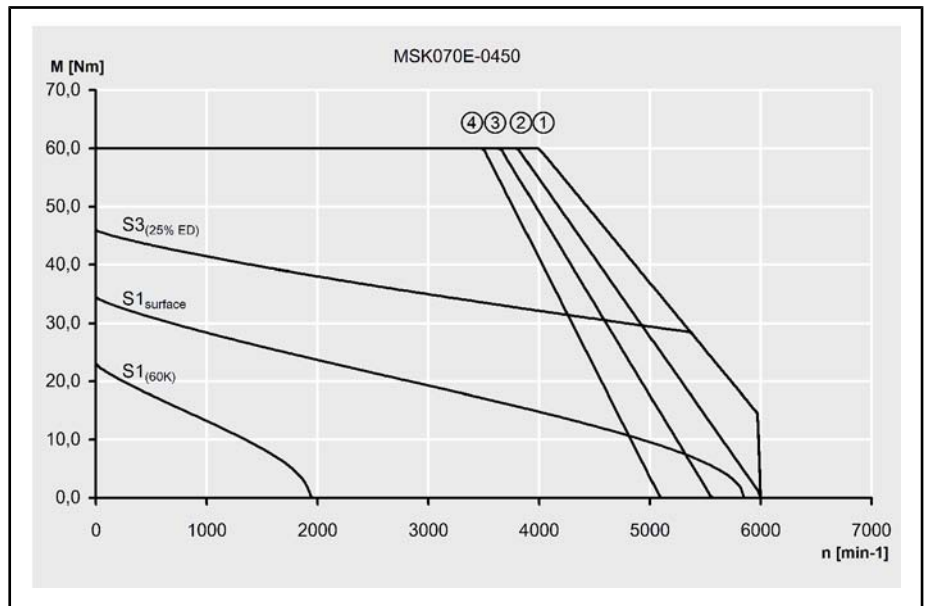

- ① Mmax for IndraDrive, controlled feed, 3x AC 400V
- ② Mmax for IndraDrive, uncontrolled feed, 3x AC 480V
- ③ Mmax for IndraDrive, uncontrolled feed, 3x AC 440V
- ④ Mmax for IndraDrive, uncontrolled feed, 3x AC 400V

Fig.4-60: Speed-torque characteristic of MSK070E-0450

Technical Data

Shaft load Diagram for determining the maximum permissible radial force F_{radial} .

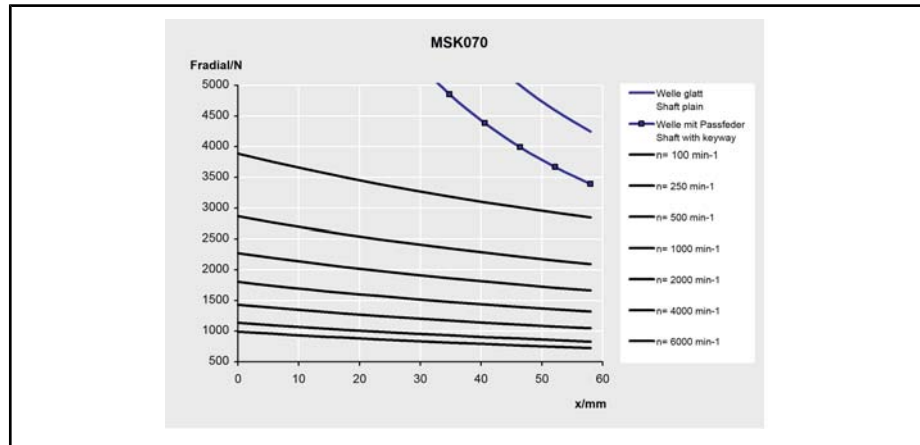

Fig.4-61: permissible radial force of MSK070 - Motors (shaft and bearing load)

The maximum permissible axial force F_{axial} is 500 N.

For additional information about permissible radial and axial forces, see [chapter 9.7 "Bearing and Shaft Load "](#) on page 164.

4.14 MSK071D Technical Data

Description	Symbol	Unit	MSK071D-0200-NN	MSK071D-0300-NN	MSK071D-0450-NN
Continuous torque at standstill, 60K	$M_{0,60}$	Nm	17,5		
Continuous current at standstill, 60K	$I_{0,60(\text{eff})}$	A	7,3	9,0	15,4
Continuous torque at standstill, 100K	$M_{0,100}$	Nm	20,0		
Continuous current at standstill, 100K	$I_{0,100(\text{eff})}$	A	8,6	10,7	17,6
Continuous torque at standstill, surface	$M_{0,S}$	Nm	26,3		
Continuous current at standstill, surface	$I_{0,S(\text{eff})}$	A	11,0	13,5	23,1
Maximum torque	M_{max}	Nm	66,0		
Maximum current	$I_{\text{max}(\text{eff})}$	A	32,8	40,5	69,3
Torque constant at 20°C	$K_{M,N}$	Nm/A	2,63	2,12	1,25
Constant voltage at 20°C	$K_{EMK,1000}$	V/min ⁻¹	162,0	134,0	77,1
Winding resistance at 20°C	R_{12}	Ohm	1,90	1,26	0,45
Winding inductivity	L_{12}	mH	14,200	10,700	3,200
Leakage capacitance of the component	C_{ab}	nF	6,9	7,2	7,8
Number of pole pairs	p	-	4		
Moment of inertia of rotor without brake ¹⁾	J_{rot}	kg*m ²	0,00255		
Thermal time constant	T_{th}	min	54,0		
Maximum speed	n_{max}	min ⁻¹	3200	3800	6000
Sound pressure level	L_p	dB[A]	<75		
Ambient temperature during operation	T_{um}	°C	0 ... 40		
Degree of protection		-	IP65		
Insulation class EN 60034-1		-	F		

1) Specified without brake. If necessary, add the moment of inertia brake.
Fig.4-62: MSK - Technical Data (natural and surface cooling)

Technical Data

Description	Symbol	Unit	MSK071D-0450-FN	
Continuous torque at standstill, 60K	M_{0_60}	Nm	17,5	
Continuous current at standstill, 60K	$I_{0_60(\text{eff})}$	A	15,4	
Continuous torque at standstill, 100K	M_{0_100}	Nm	20,0	
Continuous current at standstill, 100K	$I_{0_100(\text{eff})}$	A	17,6	
Continuous torque at standstill, liquid	M_{0_L}	Nm	33,3	
Continuous current at standstill, liquid	$I_{0_L(\text{eff})}$	A	30,3	
Maximum torque	M_{max}	Nm	66,0	
Maximum current	$I_{\text{max}(\text{eff})}$	A	69,3	
Torque constant at 20°C	K_{M_N}	Nm/A	1,25	
Constant voltage at 20°C	$K_{\text{EMK}_{1000}}$	V/min ⁻¹	77,1	
Winding resistance at 20°C	R_{12}	Ohm	0,45	
Winding inductivity	L_{12}	mH	3,200	
Leakage capacitance of the component	C_{ab}	nF	7,8	
Number of pole pairs	p	-	4	
Moment of inertia of rotor without brake ¹⁾	J_{rot}	kg*m ²	0,00255	
Thermal time constant	T_{th}	min	54,0	
Maximum speed	n_{max}	min ⁻¹	6000	
Sound pressure level	L_P	dB[A]	<75	
Ambient temperature during operation	T_{um}	°C	0 ... 40	
Degree of protection		-	IP65	
Insulation class EN 60034-1		-	F	

1) Specified without brake. If necessary, add the moment of inertia brake.
 Fig.4-63: MSK - Technical Data (natural and liquid cooling)

Description	Symbol	Unit	BREMSE-298397	BREMSE-308413
Holding torque	M_4	Nm	23,0	30,0
Rated voltage ±10%	U_N	V	24	
Rated current	I_N	A	0,79	0,94
Connection time	t_1	ms	130	35
Disconnection time	t_2	ms	180	125

Description	Symbol	Unit	BREMSE-298397	BREMSE-308413
Moment of inertia brake	J_{rot}	kg*m2	0,000300	
Mass brake	M_{Br}	kg	1,6	

Fig.4-64: MSK071: Holding brake - Technical data (optional)

Description	Symbol	Unit	MSK071D
Nominal power loss	P_{vN}	W	900
Coolant inlet temperature ¹⁾	ϑ_{ein}	°C	10 ... 40
Coolant temperature raise with P_{vN}	$\Delta\vartheta_N$	°C	10
Minimum necessary required coolant flow for $\Delta\vartheta_N$ ²⁾	Q_N	l/min	1,3
Pressure decrease at Q_N ^{2) 3)}	Δp_N	bar	0,6
Maximum system pressure	P_{max}	bar	3,0
Volume liquid cooling duct	V	l	0,05
pH-Value coolant			6 ... 8
Materials with coolant contact			
Flange, end shield			Al Mg 5 F32
Motor housing			Al Mg Si 0,5 F22
O-ring			Viton

1) Danger of condensation! The coolant inlet temperature should be max. 5° C under the real environmental temperature.

2) At coolant water.

3) For deviating discharge values notice the discharge diagram.

Fig.4-65: Technical data liquid coolant for MSK071D

Technical Data

Speed-torque characteristics

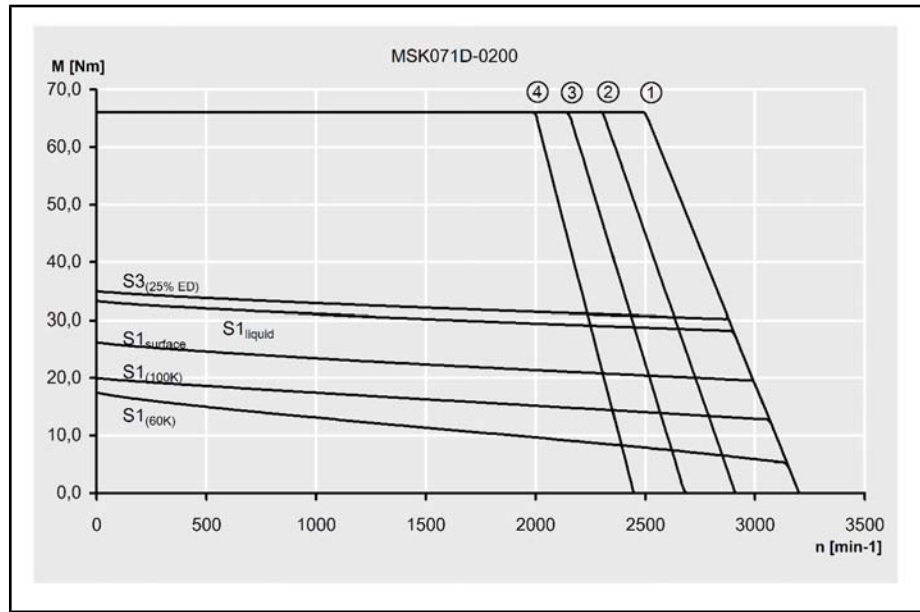

- ① Mmax for IndraDrive, controlled feed, 3x AC 400V
- ② Mmax for IndraDrive, uncontrolled feed, 3x AC 480V
- ③ Mmax for IndraDrive, uncontrolled feed, 3x AC 440V
- ④ Mmax for IndraDrive, uncontrolled feed, 3x AC 400V

Fig.4-66: Speed-torque characteristic of MSK071D-0200

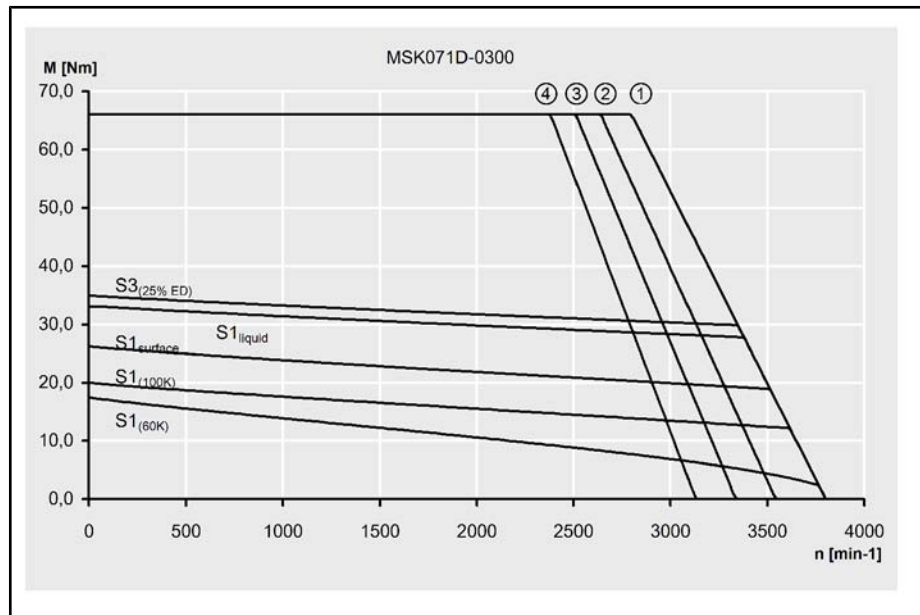

- ① Mmax for IndraDrive, controlled feed, 3x AC 400V
- ② Mmax for IndraDrive, uncontrolled feed, 3x AC 480V
- ③ Mmax for IndraDrive, uncontrolled feed, 3x AC 440V
- ④ Mmax for IndraDrive, uncontrolled feed, 3x AC 400V

Fig.4-67: Speed-torque characteristic of MSK071D-0300

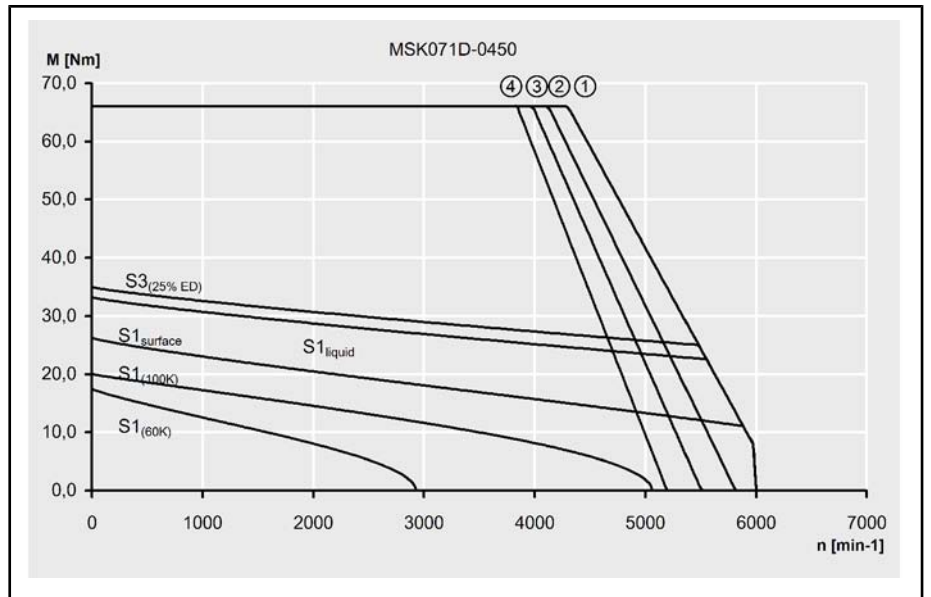

- ① Mmax for IndraDrive, controlled feed, 3x AC 400V
- ② Mmax for IndraDrive, uncontrolled feed, 3x AC 480V
- ③ Mmax for IndraDrive, uncontrolled feed, 3x AC 440V
- ④ Mmax for IndraDrive, uncontrolled feed, 3x AC 400V

Fig.4-68: Speed-torque characteristic of MSK071D-0450

Shaft load

Diagram for determining the maximum permissible radial force F_{radial} .

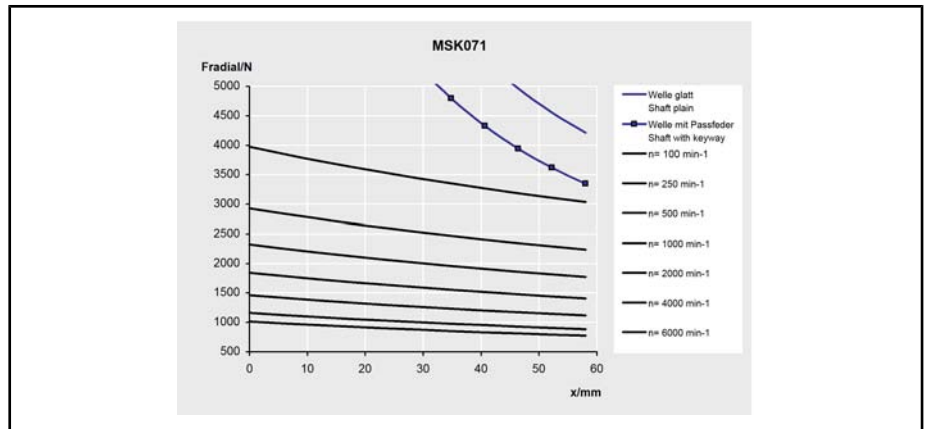

Fig.4-69: permissible radial force of MSK071 - Motors (shaft and bearing load)

The maximum permissible axial force F_{axial} is 500 N.

For additional information about permissible radial and axial forces, see [chapter 9.7 "Bearing and Shaft Load"](#) on page 164.

Technical Data

4.15 MSK071E Technical Data

Description	Symbol	Unit	MSK071E-0200-NN	MSK071E-0300-NN	MSK071E-0450-NN
Continuous torque at standstill, 60K	M_{0_60}	Nm	23,0		
Continuous current at standstill, 60K	$I_{0_60(\text{eff})}$	A	10,1	12,5	20,0
Continuous torque at standstill, 100K	M_{0_100}	Nm	28,0		
Continuous current at standstill, 100K	$I_{0_100(\text{eff})}$	A	12,6	15,2	24,4
Continuous torque at standstill, surface	M_{0_S}	Nm	34,5		
Continuous current at standstill, surface	$I_{0_S(\text{eff})}$	A	15,2	18,8	30,0
Maximum torque	M_{max}	Nm	84,0		
Maximum current	$I_{\text{max}(\text{eff})}$	A	45,5	56,3	90,1
Torque constant at 20°C	K_{M_N}	Nm/A	2,51	2,05	1,29
Constant voltage at 20°C	$K_{EMK_0}^{EMK_100}$	V/min ⁻¹	154,6	126,4	82,7
Winding resistance at 20°C	R_{12}	Ohm	1,16	0,79	0,32
Winding inductivity	L_{12}	mH	9,150	6,200	2,600
Leakage capacitance of the component	C_{ab}	nF	8,9	9,3	9,5
Number of pole pairs	p	-	4		
Moment of inertia of rotor without brake ¹⁾	J_{rot}	kg*m ²	0,00290		
Thermal time constant	T_{th}	min	75,0	19,8	
Maximum speed	n_{max}	min ⁻¹	3400	4200	6000
Sound pressure level	L_p	dB[A]	<75		
Ambient temperature during operation	T_{um}	°C	0 ... 40		
Degree of protection		-	IP65		
Insulation class EN 60034-1		-	F		

1) Specified without brake. If necessary, add the moment of inertia brake.
Fig.4-70: MSK - Technical Data (natural and surface cooling)

Description	Symbol	Unit	MSK071E-0450-FN	
Continuous torque at standstill, 60K	M_{0_60}	Nm	23,0	
Continuous current at standstill, 60K	$I_{0_60(\text{eff})}$	A	20,0	
Continuous torque at standstill, 100K	M_{0_100}	Nm	28,0	
Continuous current at standstill, 100K	$I_{0_100(\text{eff})}$	A	24,4	
Continuous torque at standstill, liquid	M_{0_L}	Nm	43,7	
Continuous current at standstill, liquid	$I_{0_L(\text{eff})}$	A	38,0	
Maximum torque	M_{max}	Nm	84,0	
Maximum current	$I_{\text{max}(\text{eff})}$	A	90,1	
Torque constant at 20°C	K_{M_N}	Nm/A	1,29	
Constant voltage at 20°C	$K_{\text{EMK_1000}}$	V/min ⁻¹	82,7	
Winding resistance at 20°C	R_{12}	Ohm	0,32	
Winding inductivity	L_{12}	mH	2,600	
Leakage capacitance of the component	C_{ab}	nF	9,5	
Number of pole pairs	p	-	4	
Moment of inertia of rotor without brake ¹⁾	J_{rot}	kg*m ²	0,00290	
Thermal time constant	T_{th}	min	19,8	
Maximum speed	n_{max}	min ⁻¹	6000	
Sound pressure level	L_{p}	dB[A]	<75	
Ambient temperature during operation	T_{um}	°C	0 ... 40	
Degree of protection		-	IP65	
Insulation class EN 60034-1		-	F	

1) Specified without brake. If necessary, add the moment of inertia brake.
Fig.4-71: MSK - Technical Data (natural and liquid cooling)

Description	Symbol	Unit	BREMSE-298397	BREMSE-308413
Holding torque	M_4	Nm	23,0	30,0
Rated voltage ±10%	U_N	V	24	
Rated current	I_N	A	0,79	0,94
Connection time	t_1	ms	130	35
Disconnection time	t_2	ms	180	125

Technical Data

Description	Symbol	Unit	BREMSE-298397	BREMSE-308413
Moment of inertia brake	J_{rot}	kg*m ²	0,000300	
Mass brake	M_{Br}	kg	1,6	

Fig.4-72: MSK071: Holding brake - Technical data (optional)

Description	Symbol	Unit	MSK071E
Nominal power loss	P_{vN}	W	1000
Coolant inlet temperature ¹⁾	ϑ_{ein}	°C	10 ... 40
Coolant temperature raise with P_{vN}	$\Delta\vartheta_N$	°C	10
Minimum necessary required coolant flow for $\Delta\vartheta_N$ ²⁾	Q_N	l/min	1,4
Pressure decrease at Q_N ^{2) 3)}	Δp_N	bar	0,7
Maximum system pressure	P_{max}	bar	3,0
Volume liquid cooling duct	V	l	0,06
pH-Value coolant			6 ... 8
Materials with coolant contact			
Flange, end shield			Al Mg 5 F32
Motor housing			Al Mg Si 0,5 F22
O-ring			Viton

- 1) Danger of condensation! The coolant inlet temperature should be max. 5° C under the real environmental temperature.
- 2) At coolant water.
- 3) For devating discharge values notice the discharge diagram.

Fig.4-73: Technical data liquid coolant for MSK071E

Speed-torque characteristics

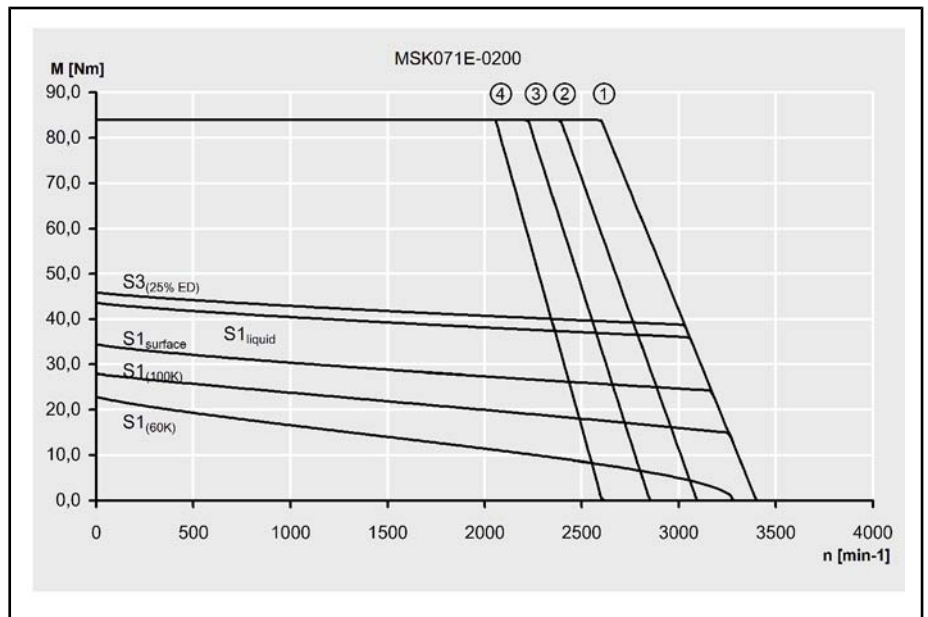

- ① Mmax for IndraDrive, controlled feed, 3x AC 400V
- ② Mmax for IndraDrive, uncontrolled feed, 3x AC 480V
- ③ Mmax for IndraDrive, uncontrolled feed, 3x AC 440V
- ④ Mmax for IndraDrive, uncontrolled feed, 3x AC 400V

Fig.4-74: Speed-torque characteristic of MSK071E-0200

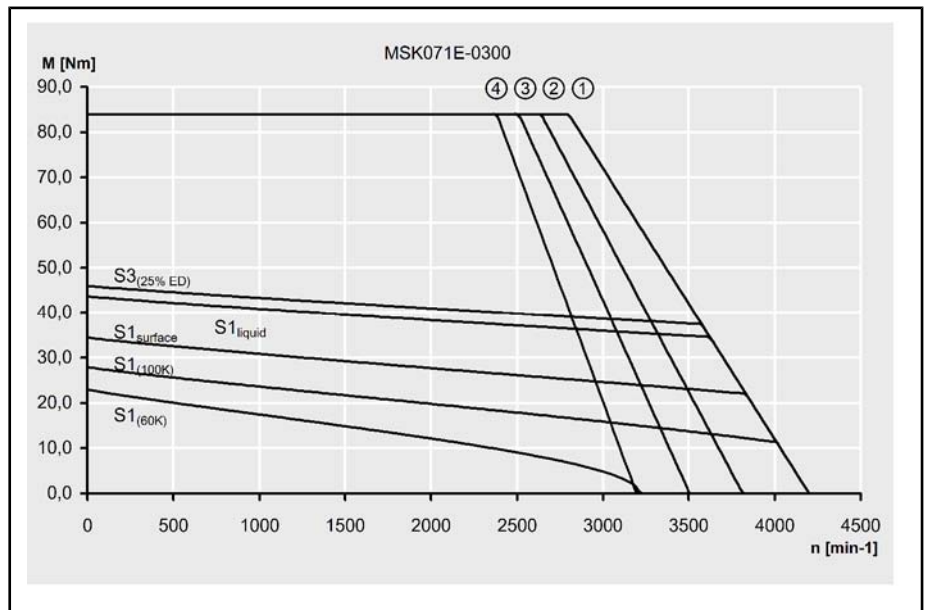

- ① Mmax for IndraDrive, controlled feed, 3x AC 400V
- ② Mmax for IndraDrive, uncontrolled feed, 3x AC 480V
- ③ Mmax for IndraDrive, uncontrolled feed, 3x AC 440V
- ④ Mmax for IndraDrive, uncontrolled feed, 3x AC 400V

Fig.4-75: Speed-torque characteristic of MSK071E-0300

Technical Data

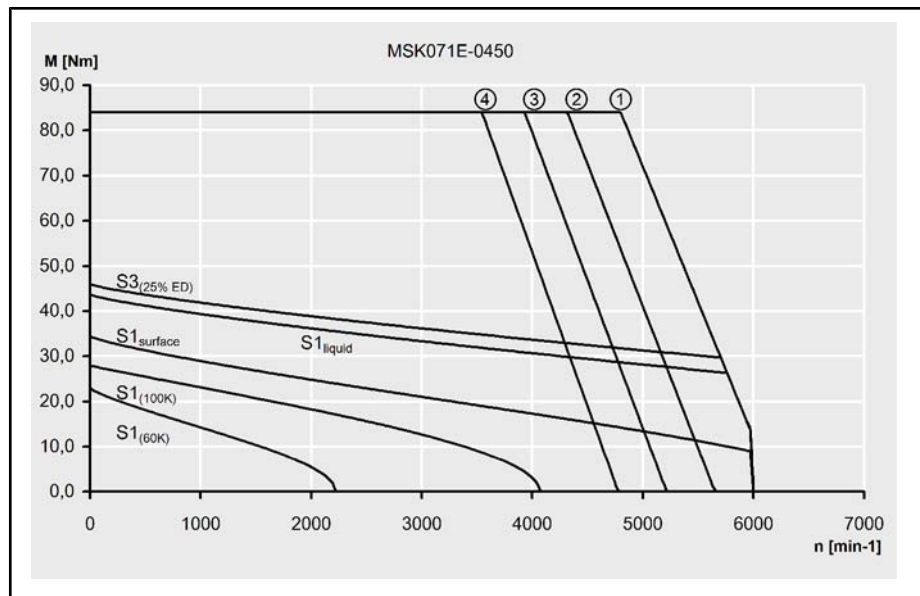

- ① Mmax for IndraDrive, controlled feed, 3x AC 400V
- ② Mmax for IndraDrive, uncontrolled feed, 3x AC 480V
- ③ Mmax for IndraDrive, uncontrolled feed, 3x AC 440V
- ④ Mmax for IndraDrive, uncontrolled feed, 3x AC 400V

Fig.4-76: Speed-torque characteristic of MSK071E-0450

Shaft load Diagram for determining the maximum permissible radial force F_{radial} .

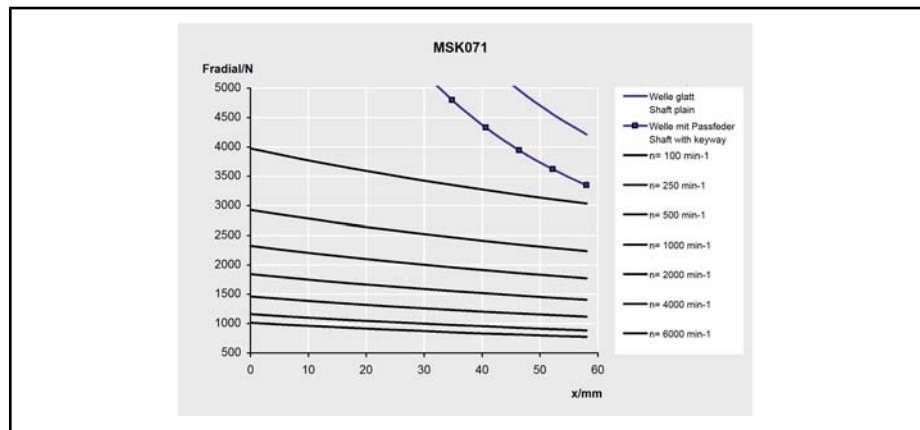

Fig.4-77: permissible radial force of MSK071 - Motors (shaft and bearing load)

The maximum permissible axial force F_{axial} is 500 N .

For additional information about permissible radial and axial forces, see [chapter 9.7 "Bearing and Shaft Load "](#) on page 164.

4.16 MSK076C Technical Data

Description	Symbol	Unit	MSK076C-0300-NN	MSK076C-0450-NN
Continuous torque at standstill, 60K	M_{0_60}	Nm	12,0	
Continuous current at standstill, 60K	$I_{0_60(\text{eff})}$	A	7,2	12,2
Continuous torque at standstill, 100K	M_{0_100}	Nm	13,5	
Continuous current at standstill, 100K	$I_{0_100(\text{eff})}$	A	8,1	13,7
Maximum torque	M_{max}	Nm	43,5	
Maximum current	$I_{\text{max}(\text{eff})}$	A	32,4	54,9
Torque constant at 20°C	K_{M_N}	Nm/A	1,84	1,14
Constant voltage at 20°C	K_{EMK_1000}	V/min ⁻¹	113,0	70,5
Winding resistance at 20°C	R_{12}	Ohm	1,85	0,71
Winding inductivity	L_{12}	mH	12,600	4,700
Leakage capacitance of the component	C_{ab}	nF	6,5	6,0
Number of pole pairs	p	-	4	
Moment of inertia of rotor without brake ¹⁾	J_{rot}	kg*m ²	0,00430	
Thermal time constant	T_{th}	min	60,0	
Maximum speed	n_{max}	min ⁻¹	4700	5000
Sound pressure level	L_p	dB[A]	< 75	
Ambient temperature during operation	T_{um}	°C	0 ... 40	
Degree of protection		-	IP65	
Insulation class EN 60034-1		-	F	

1) Specified without brake. If necessary, add the moment of inertia brake.
Fig.4-78: MSK - Technical Data (natural cooling)

Description	Symbol	Unit	BREMSE-277525
Holding torque	M_4	Nm	11,0
Rated voltage ±10%	U_N	V	24
Rated current	I_N	A	0,71
Connection time	t_1	ms	13
Disconnection time	t_2	ms	30
Moment of inertia brake	J_{rot}	kg*m ²	0,000360
Mass brake	M_{Br}	kg	1,1

Fig.4-79: MSK076: Holding brake - Technical data (optional)

Technical Data

Speed-torque characteristics

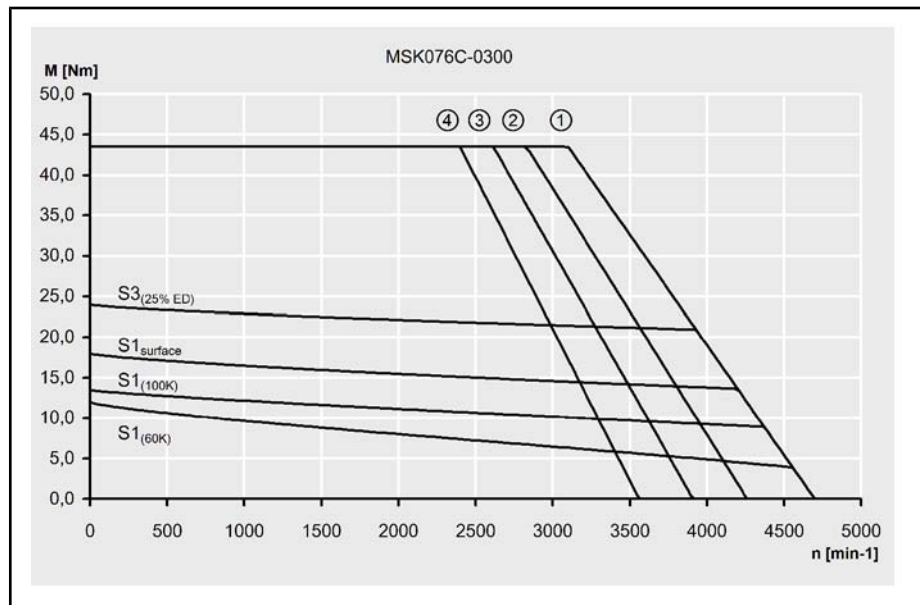

- ① Mmax for IndraDrive, controlled feed, 3x AC 400V
- ② Mmax for IndraDrive, uncontrolled feed, 3x AC 480V
- ③ Mmax for IndraDrive, uncontrolled feed, 3x AC 440V
- ④ Mmax for IndraDrive, uncontrolled feed, 3x AC 400V

Fig.4-80: Speed-torque characteristic of MSK076C-0300

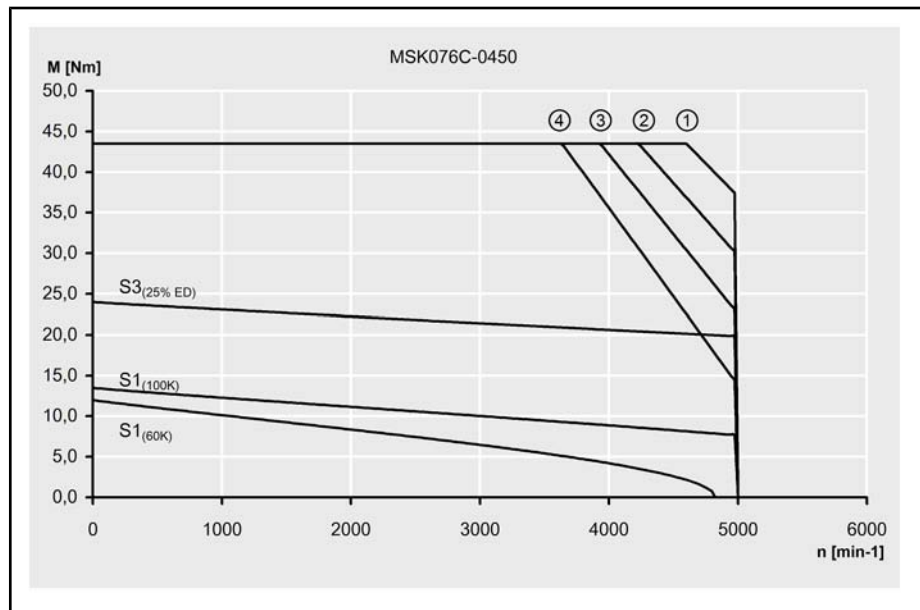

- ① Mmax for IndraDrive, controlled feed, 3x AC 400V
- ② Mmax for IndraDrive, uncontrolled feed, 3x AC 480V
- ③ Mmax for IndraDrive, uncontrolled feed, 3x AC 440V
- ④ Mmax for IndraDrive, uncontrolled feed, 3x AC 400V

Fig.4-81: Speed-torque characteristic of MSK076C-0450

Shaft load Diagram for determining the maximum permissible radial force F_{radial} .

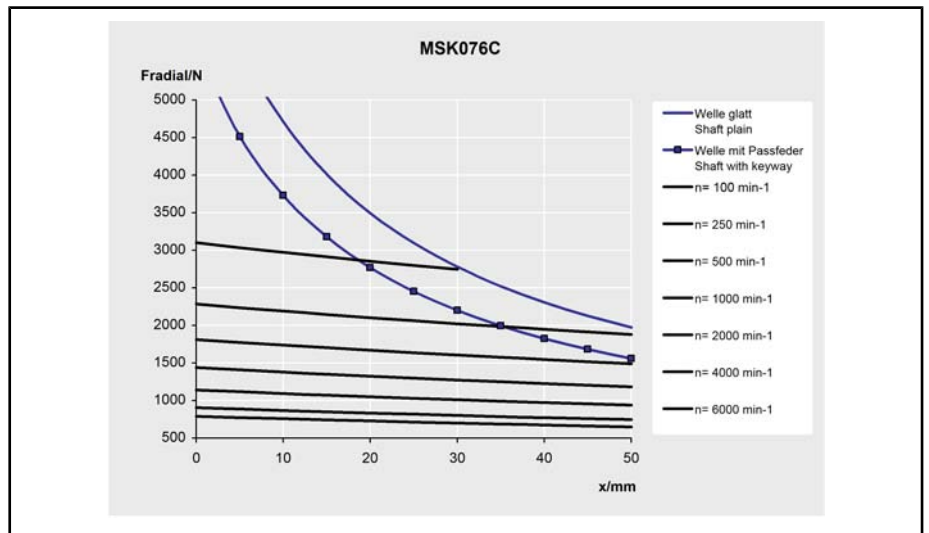

Fig.4-82: permissible radial force of MSK076 - Motors (shaft and bearing load)

The maximum permissible axial force F_{axial} is 200 N.

For additional information about permissible radial and axial forces, see [chapter 9.7 "Bearing and Shaft Load "](#) on page 164.

Technical Data

4.17 MSK100B Technical Data

Description	Symbol	Unit	MSK100B-0200-NN	MSK100B-0300-NN	MSK100B-0400-NN	MSK100B-0450-NN
Continuous torque at standstill, 60K	$M_{0,60}$	Nm	28,0			
Continuous current at standstill, 60K	$I_{0,60(\text{eff})}$	A	14,7	17,4	23,7	24,6
Continuous torque at standstill, 100K	$M_{0,100}$	Nm	33,0			
Continuous current at standstill, 100K	$I_{0,100(\text{eff})}$	A	17,3	20,5	30,8	32,0
Continuous torque at standstill, surface	$M_{0,S}$	Nm	42,0			
Continuous current at standstill, surface	$I_{0,S(\text{eff})}$	A	22,1	26,1	37,8	36,9
Maximum torque	M_{max}	Nm	102,0			
Maximum current	$I_{\text{max}(\text{eff})}$	A	66,2	78,3	106,7	110,7
Torque constant at 20°C	$K_{M,N}$	Nm/A	2,10	1,77	1,30	1,14
Constant voltage at 20°C	$K_{EMK,1000}$	V/min ⁻¹	129,5	108,5	80,0	70,0
Winding resistance at 20°C	R_{12}	Ohm	0,58	0,43	0,23	0,17
Winding inductivity	L_{12}	mH	7,600	5,500	3,100	2,200
Leakage capacitance of the component	C_{ab}	nF	10,3	9,3	10,3	
Number of pole pairs	p	-	4			
Moment of inertia of rotor without brake ¹⁾	J_{rot}	kg*m ²	0,01920			
Thermal time constant	T_{th}	min	40,0			
Maximum speed	n_{max}	min ⁻¹	4100	4750	4500	
Sound pressure level	L_p	dB[A]	<75			
Ambient temperature during operation	T_{um}	°C	0 ... 40			
Degree of protection		-	IP65			
Insulation class EN 60034-1		-	F			

1) Specified without brake. If necessary, add the moment of inertia brake.
Fig.4-83: MSK - Technical Data (natural and surface cooling)

Description	Symbol	Unit	BREMSE-276088	BREMSE-296482
Holding torque	M_4	Nm	70,0	32,0
Rated voltage ±10%	U_N	V	24	
Rated current	I_N	A	1,29	0,93

Description	Symbol	Unit	BREMSE-276088	BREMSE-296482
Connection time	t_1	ms	53	15
Disconnection time	t_2	ms	97	115
Moment of inertia brake	J_{rot}	kg*m2	0,003000	0,001242
Mass brake	M_{Br}	kg	3,8	2,4

Fig.4-84: MSK100: Holding brake - Technical data (optional)

Speed-torque characteristics

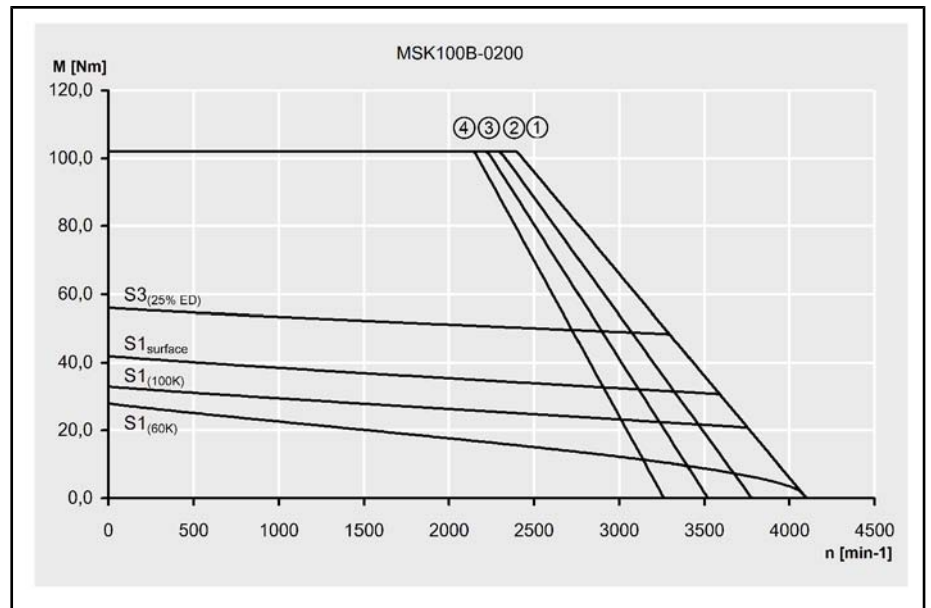

- ① Mmax for IndraDrive, controlled feed, 3x AC 400V
- ② Mmax for IndraDrive, uncontrolled feed, 3x AC 480V
- ③ Mmax for IndraDrive, uncontrolled feed, 3x AC 440V
- ④ Mmax for IndraDrive, uncontrolled feed, 3x AC 400V

Fig.4-85: Speed-torque characteristic of MSK100B-0200

Technical Data

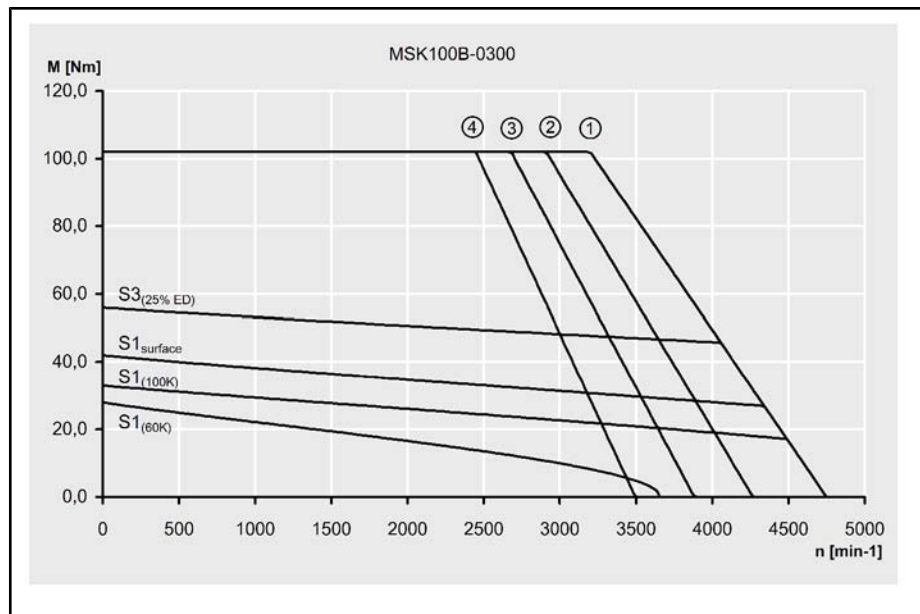

- ① Mmax for IndraDrive, controlled feed, 3x AC 400V
- ② Mmax for IndraDrive, uncontrolled feed, 3x AC 480V
- ③ Mmax for IndraDrive, uncontrolled feed, 3x AC 440V
- ④ Mmax for IndraDrive, uncontrolled feed, 3x AC 400V

Fig.4-86: Speed-torque characteristic of MSK100B-0300

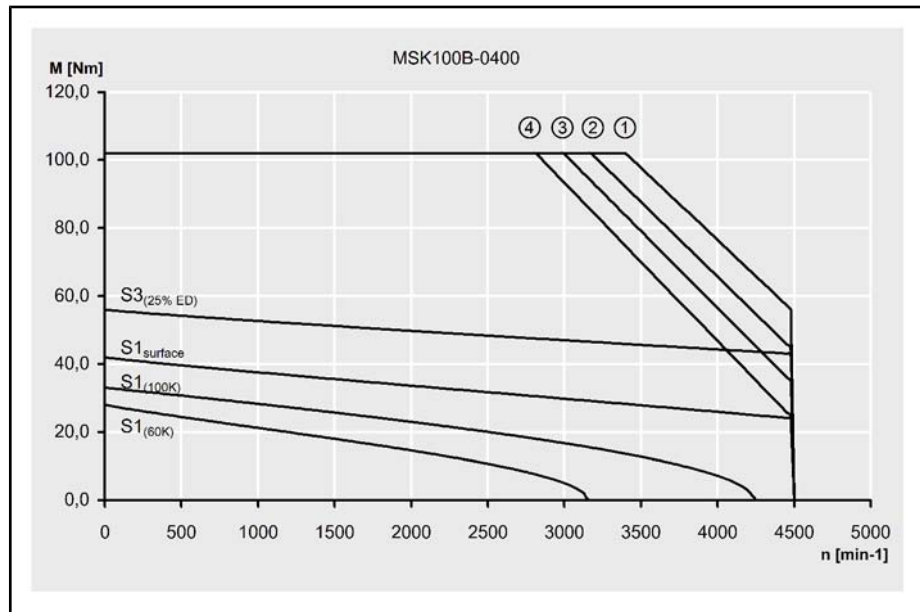

- ① Mmax for IndraDrive, controlled feed, 3x AC 400V
- ② Mmax for IndraDrive, uncontrolled feed, 3x AC 480V
- ③ Mmax for IndraDrive, uncontrolled feed, 3x AC 440V
- ④ Mmax for IndraDrive, uncontrolled feed, 3x AC 400V

Fig.4-87: Speed-torque characteristic of MSK100B-0400

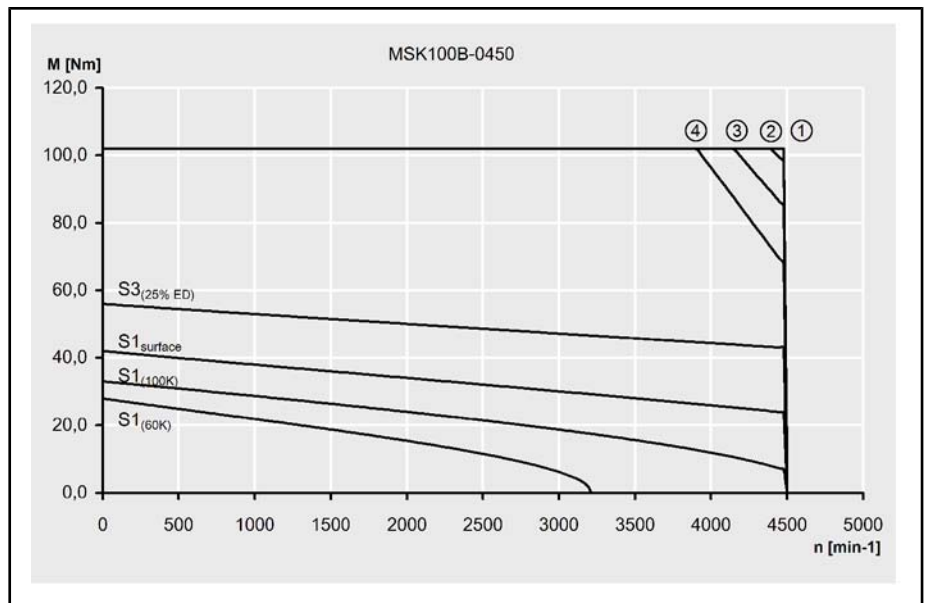

- ① Mmax for IndraDrive, controlled feed, 3x AC 400V
- ② Mmax for IndraDrive, uncontrolled feed, 3x AC 480V
- ③ Mmax for IndraDrive, uncontrolled feed, 3x AC 440V
- ④ Mmax for IndraDrive, uncontrolled feed, 3x AC 400V

Fig.4-88: Speed-torque characteristic of MSK100B-0450

Shaft load

Diagram for determining the maximum permissible radial force F_{radial} .

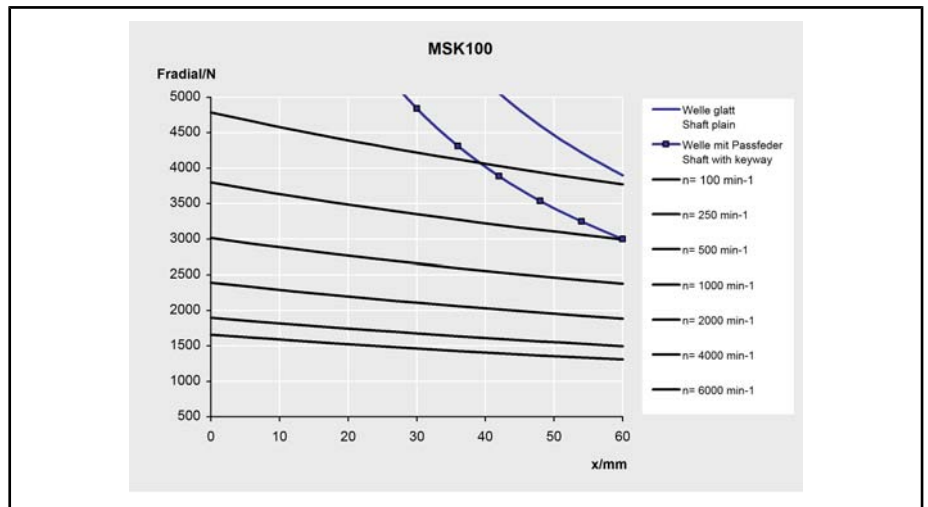

Fig.4-89: permissible radial force of MSK100 - Motors (shaft and bearing load)

The maximum permissible axial force F_{axial} is 500 N.

For additional information about permissible radial and axial forces, see [chapter 9.7 "Bearing and Shaft Load"](#) on page 164.

Technical Data

4.18 MSK100C Technical Data

Description	Symbol	Unit	MSK100C-0200-NN	MSK100C-0300-NN	MSK100C-0450-NN
Continuous torque at standstill, 60K	$M_{0,60}$	Nm	38,0		
Continuous current at standstill, 60K	$I_{0,60(\text{eff})}$	A	17,7	21,6	35,4
Continuous torque at standstill, 100K	$M_{0,100}$	Nm	43,5		
Continuous current at standstill, 100K	$I_{0,100(\text{eff})}$	A	20,3	27,0	43,5
Continuous torque at standstill, surface	$M_{0,S}$	Nm	56,8		
Continuous current at standstill, surface	$I_{0,S(\text{eff})}$	A	28,2	32,4	52,9
Maximum torque	M_{max}	Nm	148,0		
Maximum current	$I_{\text{max}(\text{eff})}$	A	79,7	97,2	159,3
Torque constant at 20°C	$K_{M,N}$	Nm/A	2,37	1,94	1,18
Constant voltage at 20°C	$K_{EMK,1000}$	V/min ⁻¹	145,5	119,1	72,7
Winding resistance at 20°C	R_{12}	Ohm	0,46	0,30	0,12
Winding inductivity	L_{12}	mH	6,700	4,200	1,600
Leakage capacitance of the component	C_{ab}	nF	12,8	14,3	13,2
Number of pole pairs	p	-	4		
Moment of inertia of rotor without brake ¹⁾	J_{rot}	kg*m ²	0,02730		
Thermal time constant	T_{th}	min	90,0		
Maximum speed	n_{max}	min ⁻¹	3500	4500	4000
Sound pressure level	L_p	dB[A]	<75		
Ambient temperature during operation	T_{um}	°C	0 ... 40		
Degree of protection		-	IP65		
Insulation class EN 60034-1		-	F		

1) Specified without brake. If necessary, add the moment of inertia brake.
Fig.4-90: MSK - Technical Data (natural and surface cooling)

Description	Symbol	Unit	BREMSE-276088	BREMSE-296482
Holding torque	M_4	Nm	70,0	32,0
Rated voltage ±10%	U_N	V	24	
Rated current	I_N	A	1,29	0,93
Connection time	t_1	ms	53	15

Description	Symbol	Unit	BREMSE-276088	BREMSE-296482
Disconnection time	t_2	ms	97	115
Moment of inertia brake	J_{rot}	kg*m2	0,003000	0,001242
Mass brake	M_{Br}	kg	3,8	2,4

Fig.4-91: MSK100: Holding brake - Technical data (optional)

Speed-torque characteristics

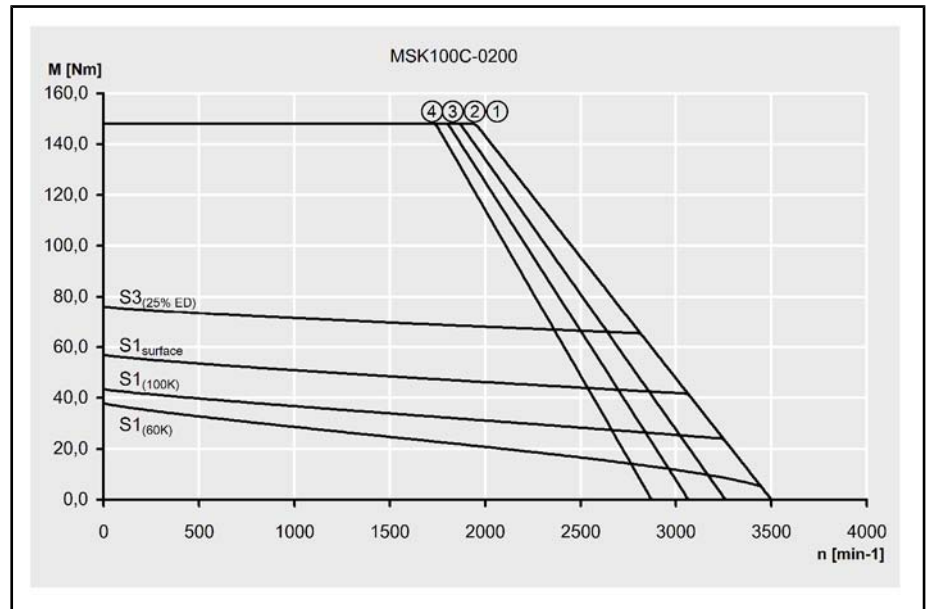

- ① Mmax for IndraDrive, controlled feed, 3x AC 400V
- ② Mmax for IndraDrive, uncontrolled feed, 3x AC 480V
- ③ Mmax for IndraDrive, uncontrolled feed, 3x AC 440V
- ④ Mmax for IndraDrive, uncontrolled feed, 3x AC 400V

Fig.4-92: Speed-torque characteristic of MSK100C-0200

Technical Data

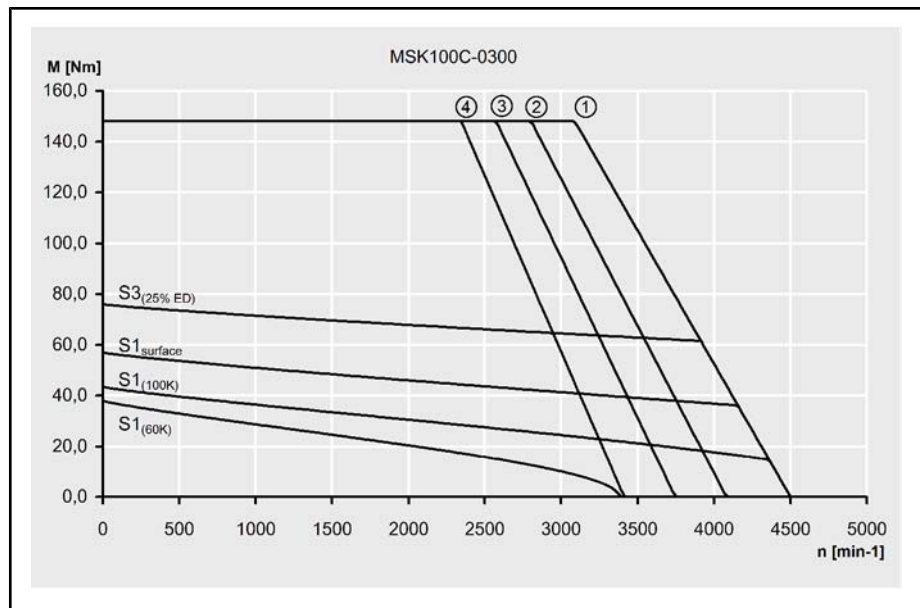

- ① Mmax for IndraDrive, controlled feed, 3x AC 400V
- ② Mmax for IndraDrive, uncontrolled feed, 3x AC 480V
- ③ Mmax for IndraDrive, uncontrolled feed, 3x AC 440V
- ④ Mmax for IndraDrive, uncontrolled feed, 3x AC 400V

Fig.4-93: Speed-torque characteristic of MSK100C-0300

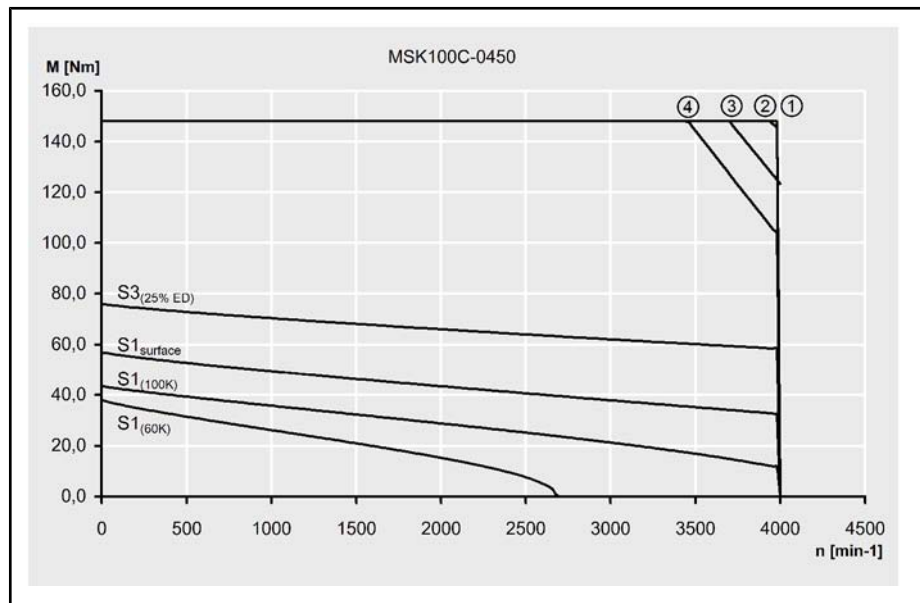

- ① Mmax for IndraDrive, controlled feed, 3x AC 400V
- ② Mmax for IndraDrive, uncontrolled feed, 3x AC 480V
- ③ Mmax for IndraDrive, uncontrolled feed, 3x AC 440V
- ④ Mmax for IndraDrive, uncontrolled feed, 3x AC 400V

Fig.4-94: Speed-torque characteristic of MSK100C-0450

Shaft load Diagram for determining the maximum permissible radial force F_{radial} .

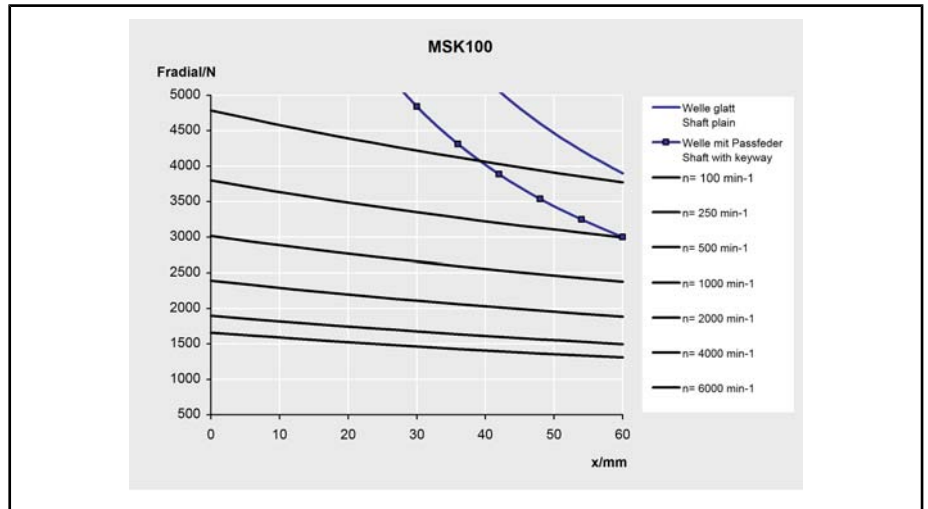

Fig.4-95: permissible radial force of MSK100 - Motors (shaft and bearing load)

The maximum permissible axial force F_{axial} is 500 N.

For additional information about permissible radial and axial forces, see [chapter 9.7 "Bearing and Shaft Load "](#) on page 164.

Technical Data

4.19 MSK100D Technical Data

Description	Symbol	Unit	MSK101D-0200-NN	MSK101D-0300-NN
Continuous torque at standstill, 60K	$M_{0,60}$	Nm	50,0	
Continuous current at standstill, 60K	$I_{0,60(\text{eff})}$	A	22,2	30,6
Continuous torque at standstill, 100K	$M_{0,100}$	Nm	57,0	
Continuous current at standstill, 100K	$I_{0,100(\text{eff})}$	A	25,3	34,9
Continuous torque at standstill, surface	$M_{0,S}$	Nm	75,0	
Continuous current at standstill, surface	$I_{0,S(\text{eff})}$	A	33,3	45,9
Maximum torque	M_{max}	Nm	160,0	
Maximum current	$I_{\text{max}(\text{eff})}$	A	99,9	137,7
Torque constant at 20°C	$K_{M,N}$	Nm/A	2,48	1,80
Constant voltage at 20°C	$K_{EMK,1000}$	V/min ⁻¹	152,0	113,0
Winding resistance at 20°C	R_{12}	Ohm	0,35	0,19
Winding inductivity	L_{12}	mH	6,000	3,200
Leakage capacitance of the component	C_{ab}	nF	13,2	9,1
Number of pole pairs	p	-	4	
Moment of inertia of rotor without brake ¹⁾	J_{rot}	kg*m ²	0,00932	
Thermal time constant	T_{th}	min	100,0	
Maximum speed	n_{max}	min ⁻¹	3400	4600
Sound pressure level	L_p	dB[A]	<75	
Ambient temperature during operation	T_{um}	°C	0 ... 40	
Degree of protection		-	IP65	
Insulation class EN 60034-1		-	F	

1) Specified without brake. If necessary, add the moment of inertia brake.
Fig.4-96: MSK - Technical Data (natural and surface cooling)

Description	Symbol	Unit	BREMSE-276088	BREMSE-296482
Holding torque	M_4	Nm	70,0	32,0
Rated voltage ±10%	U_N	V	24	
Rated current	I_N	A	1,29	0,93
Connection time	t_1	ms	53	15

Description	Symbol	Unit	BREMSE-276088	BREMSE-296482
Disconnection time	t_2	ms	97	115
Moment of inertia brake	J_{rot}	kg*m2	0,003000	0,001242
Mass brake	M_{Br}	kg	3,8	2,4

Fig.4-97: MSK100: Holding brake - Technical data (optional)

Shaft load

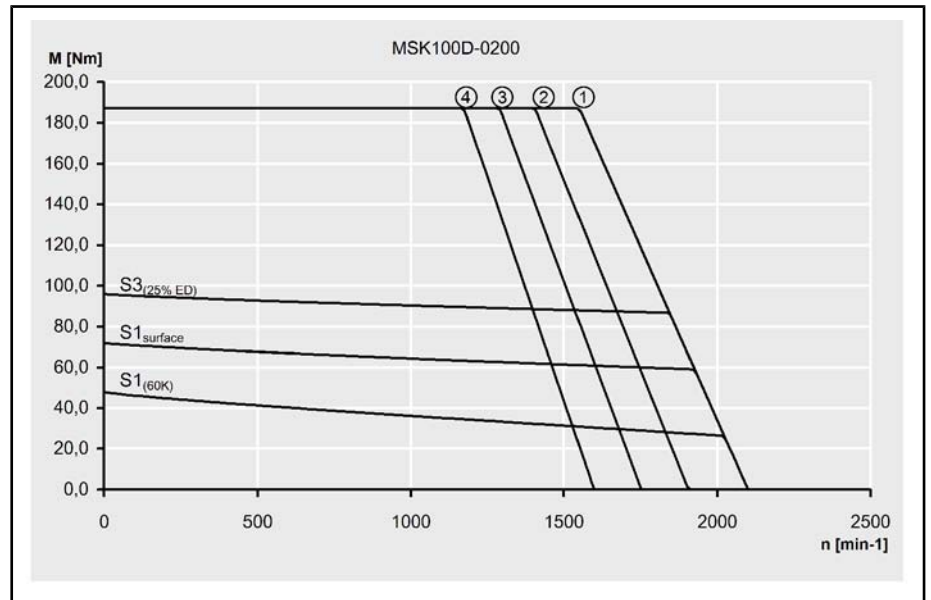

- ① Mmax for IndraDrive, controlled feed, 3x AC 400V
- ② Mmax for IndraDrive, uncontrolled feed, 3x AC 480V
- ③ Mmax for IndraDrive, uncontrolled feed, 3x AC 440V
- ④ Mmax for IndraDrive, uncontrolled feed, 3x AC 400V

Fig.4-98: Speed-torque characteristic of MSK100D-0200

Technical Data

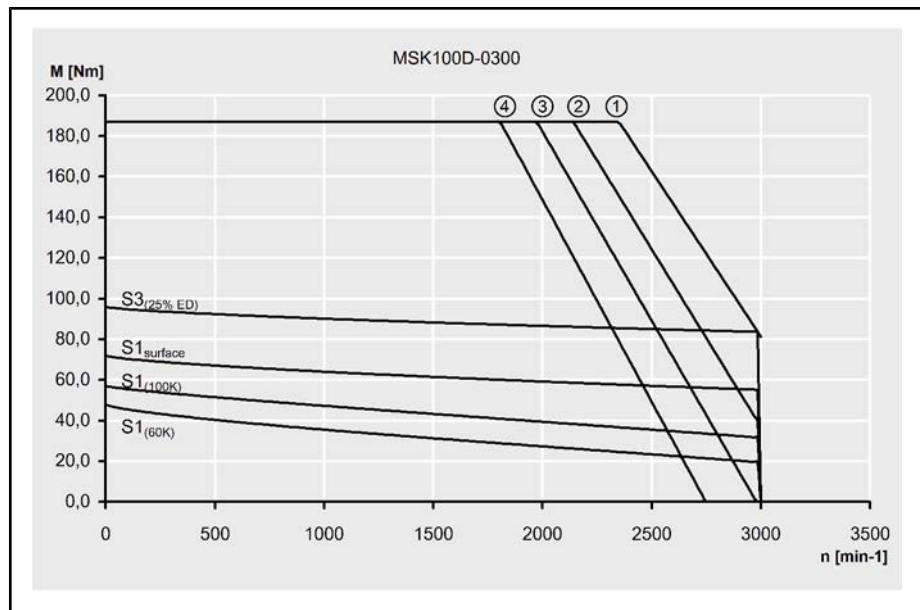

- ① Mmax for IndraDrive, controlled feed, 3x AC 400V
- ② Mmax for IndraDrive, uncontrolled feed, 3x AC 480V
- ③ Mmax for IndraDrive, uncontrolled feed, 3x AC 440V
- ④ Mmax for IndraDrive, uncontrolled feed, 3x AC 400V

Fig.4-99: Speed-torque characteristic of MSK100D-0300

Shaft load

Diagram for determining the maximum permissible radial force F_{radial} .

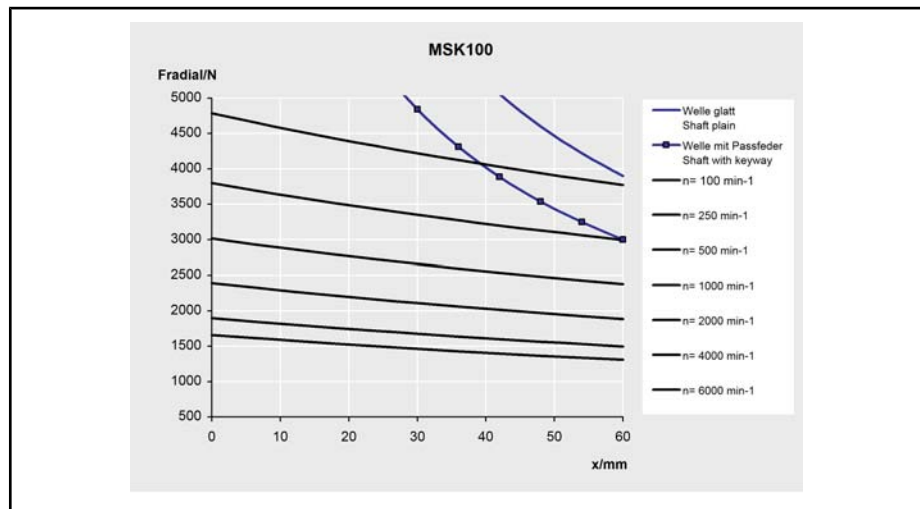

Fig.4-100: permissible radial force of MSK100 - Motors (shaft and bearing load)

The maximum permissible axial force F_{axial} is 500 N.

For additional information about permissible radial and axial forces, see [chapter 9.7 "Bearing and Shaft Load"](#) on page 164.

4.20 MSK101D Technical Data

Description	Symbol	Unit	MSK101D-0200-NN	MSK101D-0300-NN	MSK101D-0450-NN
Continuous torque at standstill, 60K	M_{0_60}	Nm	50,0		
Continuous current at standstill, 60K	$I_{0_60(\text{eff})}$	A	22,2	30,6	41,7
Continuous torque at standstill, 100K	M_{0_100}	Nm	57,0		
Continuous current at standstill, 100K	$I_{0_100(\text{eff})}$	A	25,3	34,9	50,6
Continuous torque at standstill, surface	M_{0_S}	Nm	75,0		
Continuous current at standstill, surface	$I_{0_S(\text{eff})}$	A	33,3	45,9	66,0
Maximum torque	M_{max}	Nm	160,0		
Maximum current	$I_{\text{max}(\text{eff})}$	A	99,9	137,7	187,7
Torque constant at 20°C	K_{M_N}	Nm/A	2,48	1,80	1,32
Constant voltage at 20°C	K_{EMK_1000}	V/min ⁻¹	152,0	113,0	81,0
Winding resistance at 20°C	R_{12}	Ohm	0,35	0,19	0,10
Winding inductivity	L_{12}	mH	6,000	3,200	1,700
Leakage capacitance of the component	C_{ab}	nF	13,2	9,1	13,2
Number of pole pairs	p	-	4		
Moment of inertia of rotor without brake ¹⁾	J_{rot}	kg*m ²	0,00932		
Thermal time constant	T_{th}	min	100,0		
Maximum speed	n_{max}	min ⁻¹	3400	4600	6000
Sound pressure level	L_p	dB[A]	<75		
Ambient temperature during operation	T_{um}	°C	0 ... 40		
Degree of protection		-	IP65		
Insulation class EN 60034-1		-	F		

1) Specified without brake. If necessary, add the moment of inertia brake.
Fig.4-101: MSK - Technical Data (natural and surface cooling)

Technical Data

Description	Symbol	Unit	MSK101D-0200-FN	MSK101D-0300-FN	MSK101D-0450-FN
Continuous torque at standstill, 60K	$M_{0,60}$	Nm	50,0		
Continuous current at standstill, 60K	$I_{0,60(\text{eff})}$	A	22,2	30,6	41,7
Continuous torque at standstill, 100K	$M_{0,100}$	Nm	57,0		
Continuous current at standstill, 100K	$I_{0,100(\text{eff})}$	A	26,8	34,9	50,6
Continuous torque at standstill, liquid	$M_{0,L}$	Nm	95,0		
Continuous current at standstill, liquid	$I_{0,L(\text{eff})}$	A	43,3	58,1	83,6
Maximum torque	M_{max}	Nm	160,0		
Maximum current	$I_{\text{max}(\text{eff})}$	A	99,9	137,7	187,7
Torque constant at 20°C	$K_{M,N}$	Nm/A	2,48	1,80	1,32
Constant voltage at 20°C	$K_{\text{EMK},1000}$	V/min ⁻¹	152,0	113,0	81,0
Winding resistance at 20°C	R_{12}	Ohm	0,35	0,19	0,10
Winding inductivity	L_{12}	mH	6,000	3,200	1,700
Leakage capacitance of the component	C_{ab}	nF	13,2	9,1	13,2
Number of pole pairs	p	-	4		
Moment of inertia of rotor without brake ¹⁾	J_{rot}	kg*m ²	0,00932		
Thermal time constant	T_{th}			100,0	
Maximum speed	n_{max}	min ⁻¹	3400	4600	6000
Sound pressure level	L_P	dB[A]	<75		
Ambient temperature during operation	T_{um}	°C	0 ... 40		
Degree of protection		-	IP65		
Insulation class EN 60034-1		-	F		

1) Specified without brake. If necessary, add the moment of inertia brake.
Fig.4-102: MSK - Technical Data (natural and liquid cooling)

Description	Symbol	Unit	BREMSE-276088	BREMSE-296482
Holding torque	M_4	Nm	70,0	32,0
Rated voltage ±10%	U_N	V	24	
Rated current	I_N	A	1,29	0,93
Connection time	t_1	ms	53	15
Disconnection time	t_2	ms	97	115

Description	Symbol	Unit	BREMSE-276088	BREMSE-296482
Moment of inertia brake	J_{rot}	kg*m2	0,003000	0,001242
Mass brake	M_{Br}	kg	3,8	2,4

Fig.4-103: MSK101: Holding brake - Technical data (optional)

Description	Symbol	Unit	MSK101D
Nominal power loss	P_{vN}	W	1200
Coolant inlet temperature ¹⁾	ϑ_{ein}	°C	10 ... 40
Coolant temperature raise with P_{vN}	$\Delta\vartheta_N$	°C	10
Minimum necessary required coolant flow for $\Delta\vartheta_N$ ²⁾	Q_N	l/min	1,7
Pressure decrease at Q_N ^{2) 3)}	Δp_N	bar	0,9
Maximum system pressure	P_{max}	bar	3,0
Volume liquid cooling duct	V	l	0,11
pH-Value coolant			6 ... 8
Materials with coolant contact			
Flange, end shield			Al Mg 5 F32
Motor housing			Al Mg Si 0,5 F22
O-ring			Viton

1) Danger of condensation! The coolant inlet temperature should be max. 5° C under the real environmental temperature.

2) At coolant water.

3) For deviating discharge values notice the discharge diagram.

Fig.4-104: Technical data liquid coolant for MSK101D

Technical Data

Speed-torque characteristics

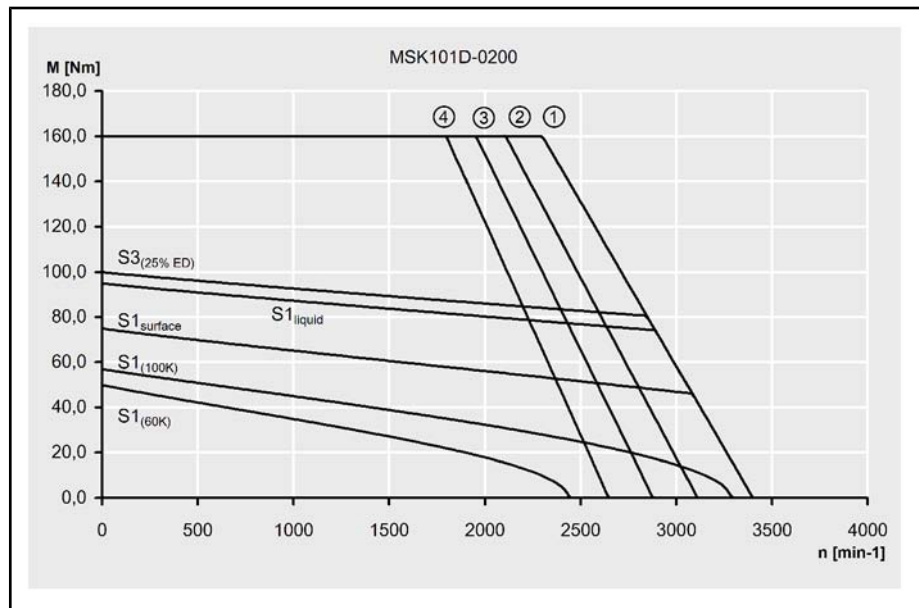

- ① Mmax for IndraDrive, controlled feed, 3x AC 400V
- ② Mmax for IndraDrive, uncontrolled feed, 3x AC 480V
- ③ Mmax for IndraDrive, uncontrolled feed, 3x AC 440V
- ④ Mmax for IndraDrive, uncontrolled feed, 3x AC 400V

Fig.4-105: Speed-torque characteristic of MSK101D-0200

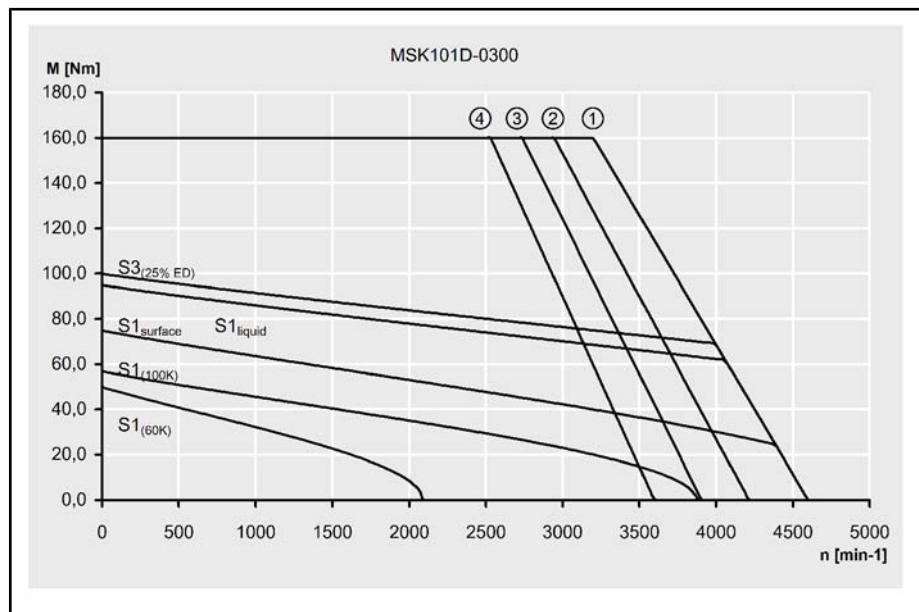

- ① Mmax for IndraDrive, controlled feed, 3x AC 400V
- ② Mmax for IndraDrive, uncontrolled feed, 3x AC 480V
- ③ Mmax for IndraDrive, uncontrolled feed, 3x AC 440V
- ④ Mmax for IndraDrive, uncontrolled feed, 3x AC 400V

Fig.4-106: Speed-torque characteristic of MSK101D-0300

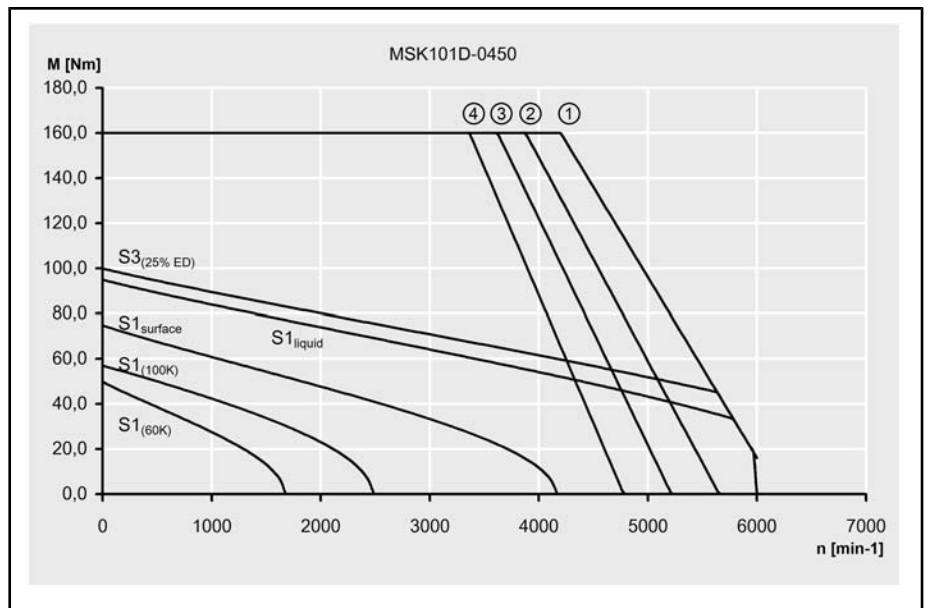

- ① Mmax for IndraDrive, controlled feed, 3x AC 400V
- ② Mmax for IndraDrive, uncontrolled feed, 3x AC 480V
- ③ Mmax for IndraDrive, uncontrolled feed, 3x AC 440V
- ④ Mmax for IndraDrive, uncontrolled feed, 3x AC 400V

Fig.4-107: Speed-torque characteristic of MSK101D-0450

Shaft load

Diagram for determining the maximum permissible radial force F_{radial} .

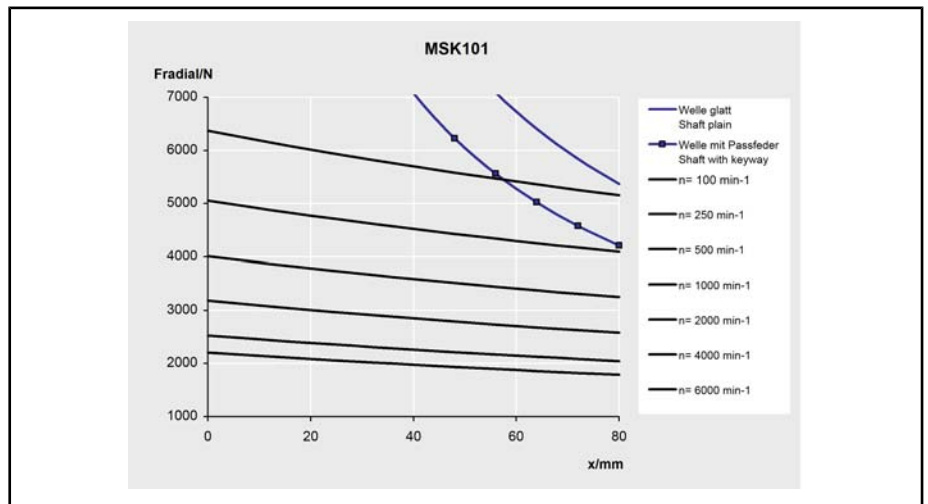

Fig.4-108: permissible radial force of MSK101 - Motors (shaft and bearing load)

The maximum permissible axial force F_{axial} is 500 N.

For additional information about permissible radial and axial forces, see [chapter 9.7 "Bearing and Shaft Load"](#) on page 164.

Technical Data

4.21 MSK101E Technical Data

Description	Symbol	Unit	MSK101E-0200-NN	MSK101E-0300-NN	MSK101E-0450-NN
Continuous torque at standstill, 60K	$M_{0,60}$	Nm	70,0		
Continuous current at standstill, 60K	$I_{0,60(\text{eff})}$	A	32,1	41,6	58,3
Continuous torque at standstill, 100K	$M_{0,100}$	Nm	80,5		
Continuous current at standstill, 100K	$I_{0,100(\text{eff})}$	A	39,0	47,8	67,6
Continuous torque at standstill, surface	$M_{0,S}$	Nm	105,0		
Continuous current at standstill, surface	$I_{0,S(\text{eff})}$	A	48,2	62,4	87,5
Maximum torque	M_{max}	Nm	231,0		
Maximum current	$I_{\text{max}(\text{eff})}$	A	144,5	187,4	262,4
Torque constant at 20°C	$K_{M,N}$	Nm/A	2,40	1,85	1,32
Constant voltage at 20°C	$K_{EMK,1000}$	V/min ⁻¹	148,0	113,8	81,2
Winding resistance at 20°C	R_{12}	Ohm	0,18	0,11	0,06
Winding inductivity	L_{12}	mH	3,300	1,960	1,080
Leakage capacitance of the component	C_{ab}	nF	15,2	16,7	
Number of pole pairs	p	-	4		
Moment of inertia of rotor without brake ¹⁾	J_{rot}	kg*m ²	0,01380		
Thermal time constant	T_{th}	min	100,0		
Maximum speed	n_{max}	min ⁻¹	3500	4600	6000
Sound pressure level	L_p	dB[A]	<75		
Ambient temperature during operation	T_{um}	°C	0 ... 40		
Degree of protection		-	IP65		
Insulation class EN 60034-1		-	F		

1) Specified without brake. If necessary, add the moment of inertia brake.
 Fig.4-109: MSK - Technical Data (natural and surface cooling)

Description	Symbol	Unit	MSK101E-0200-FN	
Continuous torque at standstill, 60K	M_{0_60}	Nm	70,0	
Continuous current at standstill, 60K	$I_{0_60(\text{eff})}$	A	32,1	
Continuous torque at standstill, 100K	M_{0_100}	Nm	80,5	
Continuous current at standstill, 100K	$I_{0_100(\text{eff})}$	A	39,0	
Continuous torque at standstill, liquid	M_{0_L}	Nm	133,0	
Continuous current at standstill, liquid	$I_{0_L(\text{eff})}$	A	63,8	
Maximum torque	M_{max}	Nm	231,0	
Maximum current	$I_{\text{max}(\text{eff})}$	A	144,5	
Torque constant at 20°C	K_{M_N}	Nm/A	2,40	
Constant voltage at 20°C	$K_{\text{EMK_1000}}$	V/min ⁻¹	148,0	
Winding resistance at 20°C	R_{12}	Ohm	0,18	
Winding inductivity	L_{12}	mH	3,300	
Leakage capacitance of the component	C_{ab}	nF	15,2	
Number of pole pairs	p	-	4	
Moment of inertia of rotor without brake ¹⁾	J_{rot}	kg*m ²	0,01380	
Thermal time constant	T_{th}	min	100,0	
Maximum speed	n_{max}	min ⁻¹	3500	
Sound pressure level	L_{p}	dB[A]	<75	
Ambient temperature during operation	T_{um}	°C	0 ... 40	
Degree of protection		-	IP65	
Insulation class EN 60034-1		-	F	

1) Specified without brake. If necessary, add the moment of inertia brake.
Fig.4-110: MSK - Technical Data (natural and liquid cooling)

Description	Symbol	Unit	BREMSE-276088	BREMSE-296482
Holding torque	M_4	Nm	70,0	32,0
Rated voltage ±10%	U_N	V	24	
Rated current	I_N	A	1,29	0,93
Connection time	t_1	ms	53	15
Disconnection time	t_2	ms	97	115

Technical Data

Description	Symbol	Unit	BREMSE-276088	BREMSE-296482
Moment of inertia brake	J_{rot}	kg*m ²	0,003000	0,001242
Mass brake	M_{Br}	kg	3,8	2,4

Fig.4-111: MSK101: Holding brake - Technical data (optional)

Description	Symbol	Unit	MSK101E
Nominal power loss	P_{vN}	W	1300
Coolant inlet temperature ¹⁾	ϑ_{ein}	°C	10 ... 40
Coolant temperature raise with P_{vN}	$\Delta\vartheta_N$	°C	10
Minimum necessary required coolant flow for $\Delta\vartheta_N$ ²⁾	Q_N	l/min	1,8
Pressure decrease at Q_N ^{2) 3)}	Δp_N	bar	1,0
Maximum system pressure	P_{max}	bar	3,0
Volume liquid cooling duct	V	l	0,14
pH-Value coolant			6 ... 8
Materials with coolant contact			
Flange, end shield			Al Mg 5 F32
Motor housing			Al Mg Si 0,5 F22
O-ring			Viton

- 1) Danger of condensation! The coolant inlet temperature should be max. 5° C under the real environmental temperature.
- 2) At coolant water.
- 3) For devating discharge values notice the discharge diagram.

Fig.4-112: Technical data liquid coolant for MSK101E

Shaft load

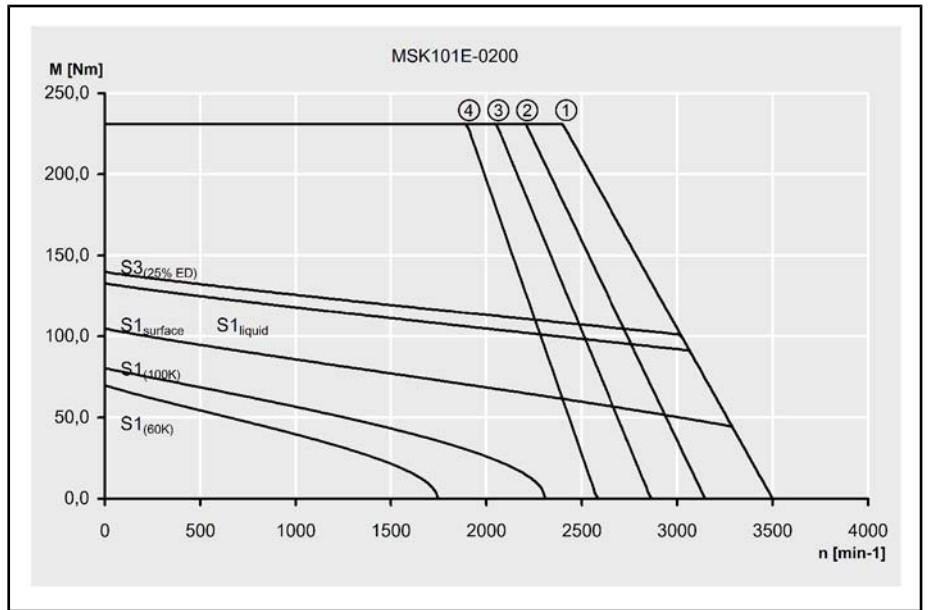

- ① Mmax for IndraDrive, controlled feed, 3x AC 400V
- ② Mmax for IndraDrive, uncontrolled feed, 3x AC 480V
- ③ Mmax for IndraDrive, uncontrolled feed, 3x AC 440V
- ④ Mmax for IndraDrive, uncontrolled feed, 3x AC 400V

Fig.4-113: Speed-torque characteristic of MSK101E-0200

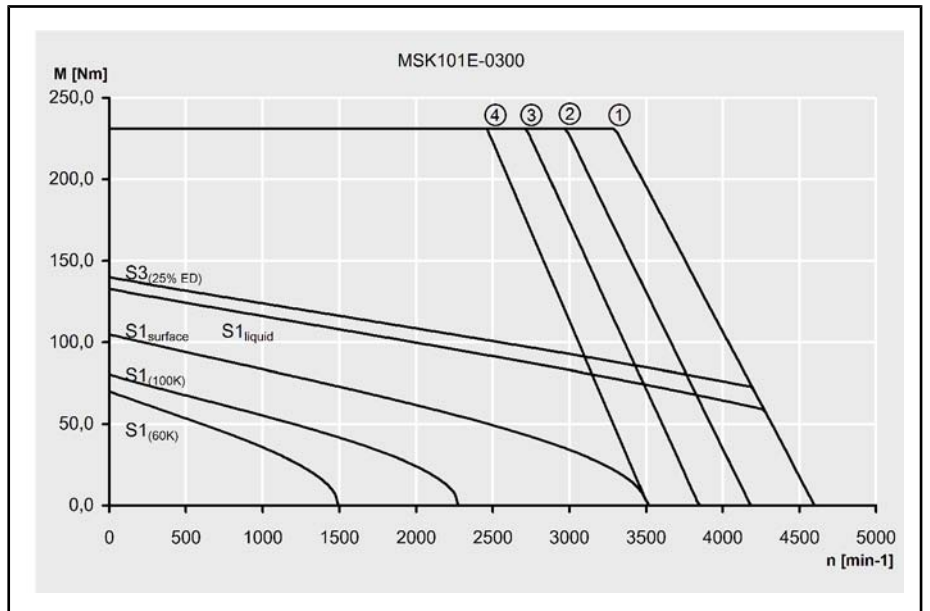

- ① Mmax for IndraDrive, controlled feed, 3x AC 400V
- ② Mmax for IndraDrive, uncontrolled feed, 3x AC 480V
- ③ Mmax for IndraDrive, uncontrolled feed, 3x AC 440V
- ④ Mmax for IndraDrive, uncontrolled feed, 3x AC 400V

Fig.4-114: Speed-torque characteristic of MSK101E-0300

Technical Data

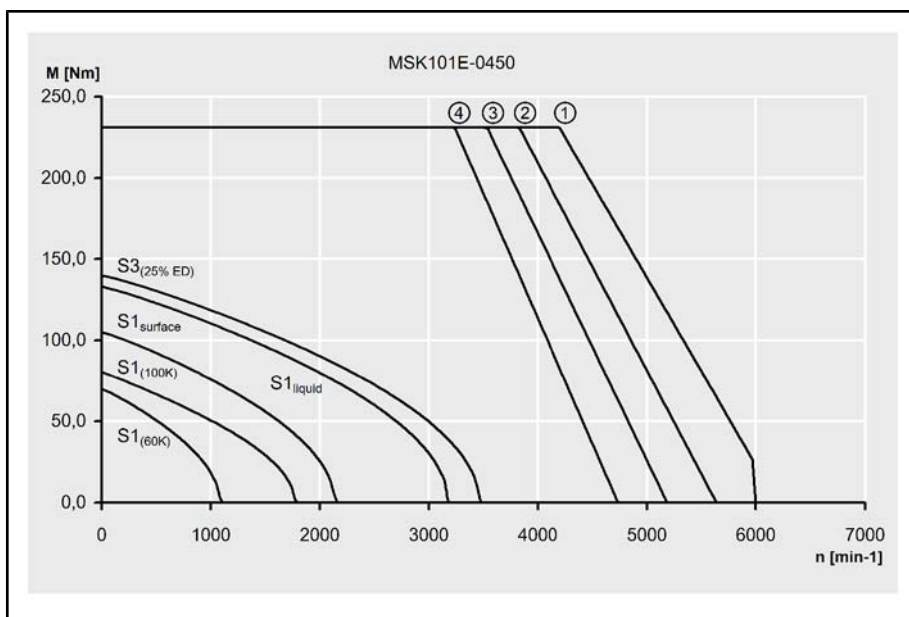

- ① Mmax for IndraDrive, controlled feed, 3x AC 400V
- ② Mmax for IndraDrive, uncontrolled feed, 3x AC 480V
- ③ Mmax for IndraDrive, uncontrolled feed, 3x AC 440V
- ④ Mmax for IndraDrive, uncontrolled feed, 3x AC 400V

Fig.4-115: Speed-torque characteristic of MSK101E-0450

Shaft load

Diagram for determining the maximum permissible radial force F_{radial} .

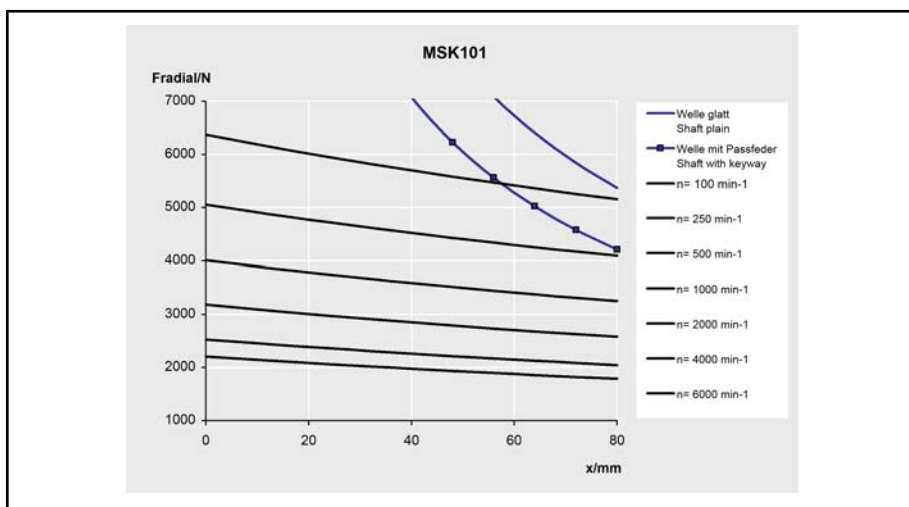

Fig.4-116: permissible radial force of MSK101 - Motors (shaft and bearing load)

The maximum permissible axial force F_{axial} is **500 N**.

For additional information about permissible radial and axial forces, see [chapter 9.7 "Bearing and Shaft Load "](#) on page 164.

5 Specifications

5.1 Basic Data – Technical Design

Motor design	Motor design B5 according to EN60034-7 (for additional information see chapter 9.4 "Design and Installation Positions " on page 160)
Housing varnish	Black (RAL 9005)
Vibration characteristics	N (normal), according to EN 60034-14
Balance characteristics	G 2.5 acc. to DIN ISO 1940-1
Concentricity, run-out and alignment	According to DIN 42955, edition 12.81 (IEC 60072-1)

Encoder	Concentricity tolerance		Run-out and alignment tolerance	
S1, M1	N	---	N	---
S2, M2	---	R	---	R

Fig.5-1: Tolerance for concentricity, run-out and alignment, depending on the encoder option

Flange	Flange according to DIN 42948, ed. 11.65.
Drive shaft, shaft end and centering hole	<p>Motors with keyway are balanced with complete key. The machine element to be driven must be balanced without a key.</p> <p>Cylindrical shaft end according to DIN 748, Part 3, ed. 07.75 IEC 60072 (-1).</p> <p>Centering hole, according to DIN 332 Part 2, Edition 05.83</p>

Motor	Corresponding keyway according to DIN 6885-A (does not belong to scope of delivery of the motors)	Centering hole according to DIN 332 Part 2, Edition 05.83
MSK030	3 x 3 x 16	DS M3
MSK040	5 x 5 x 20	DS M5
MSK050	6 x 6 x 32	DS M6
MSK060	8 x 7 x 40	DS M8
MSK061	6 x 6 x 32	DS M6
MSK070	10 x 8 x 45	DS M10
MSK071	10 x 8 x 45	DS M10
MSK076	8 x 7 x 40	DS M8
MSK100	10 x 8 x 45	DS M10
MSK101	10 x 8 x 70	DS M12

Fig.5-2: Key and centering hole

Specifications

5.4 Size MSK050

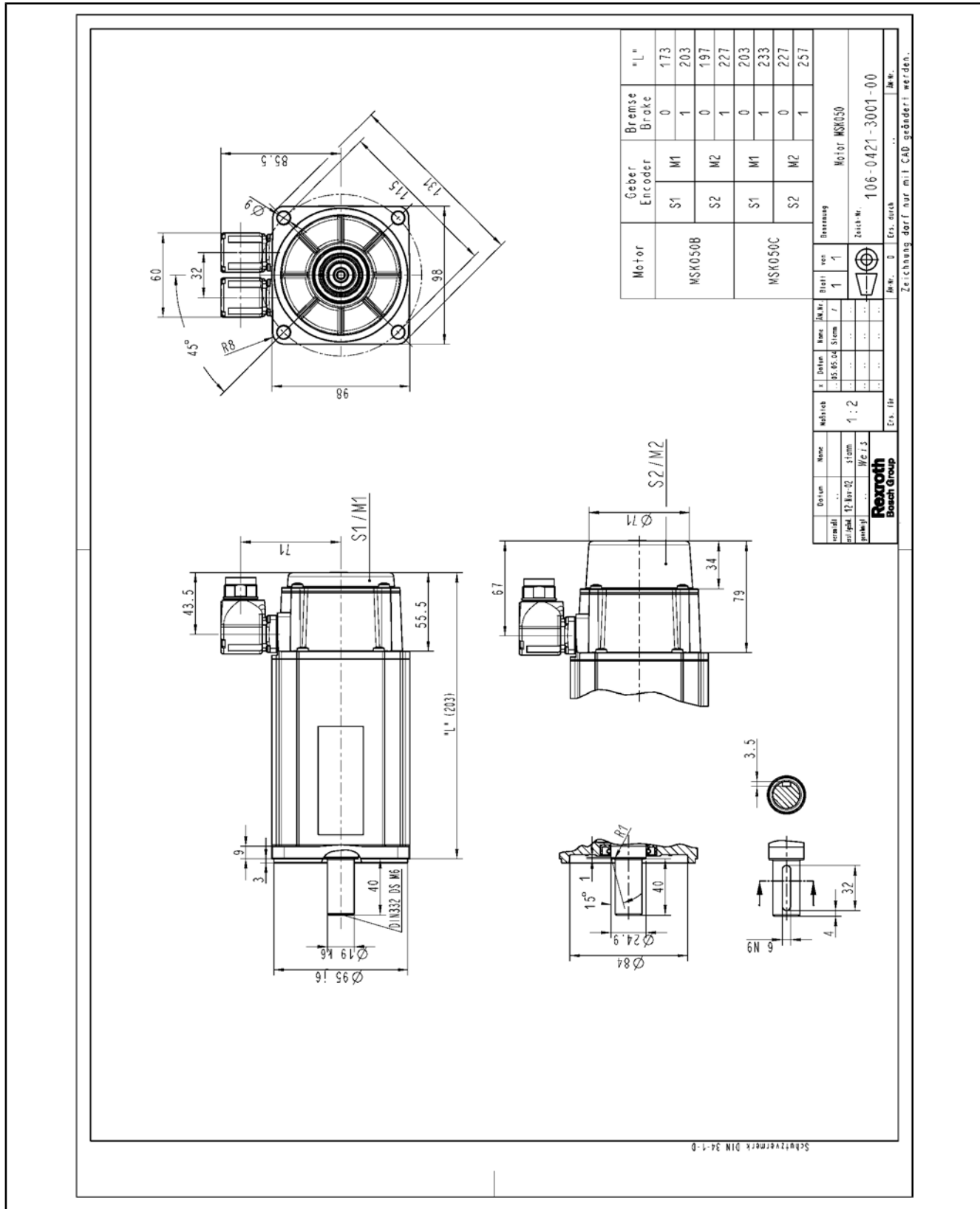

Fig.5-5: MSK050 specification

Specifications

5.6 Size MSK061

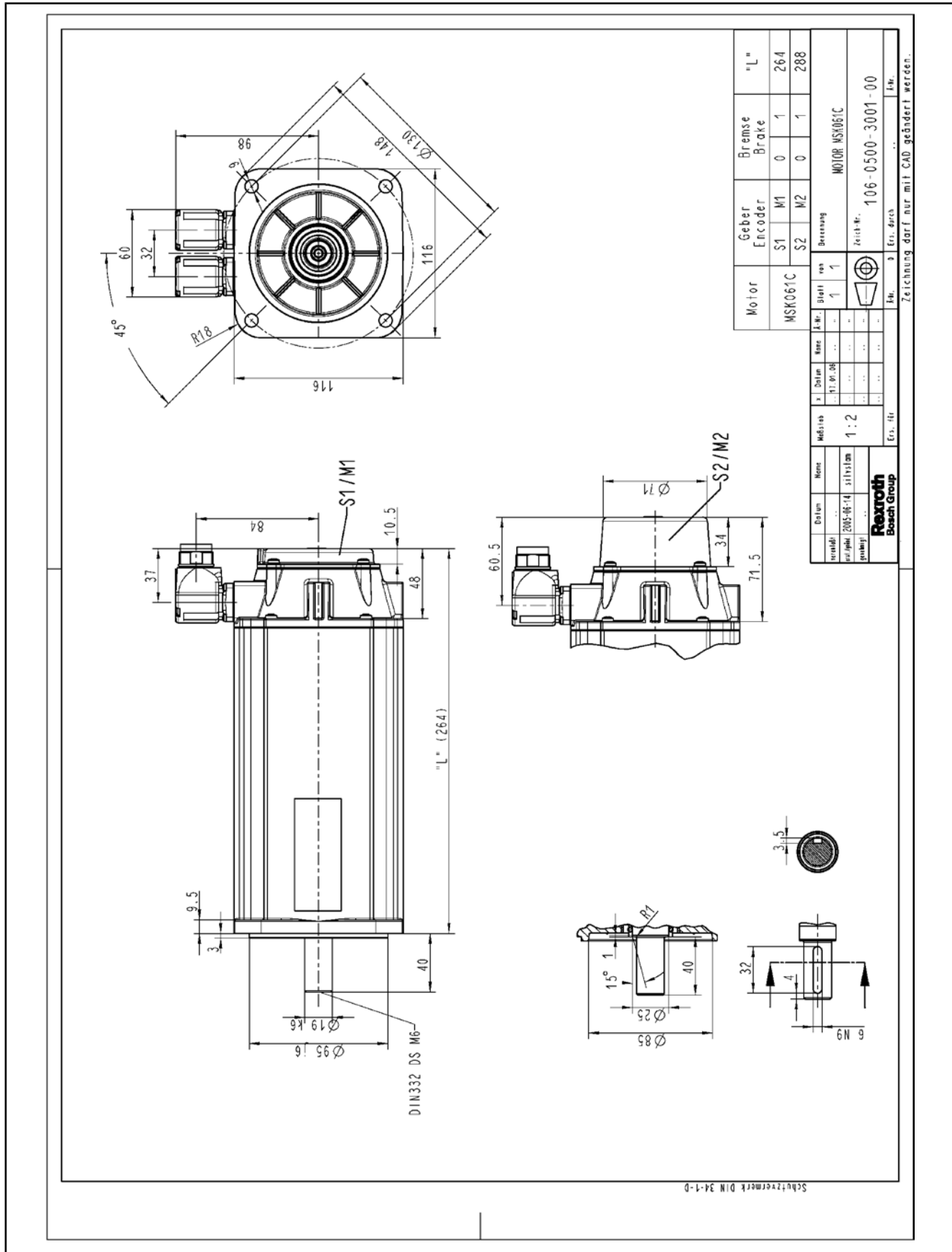

Fig.5-7: MSK061 specification

Specifications

5.8 Size MSK071

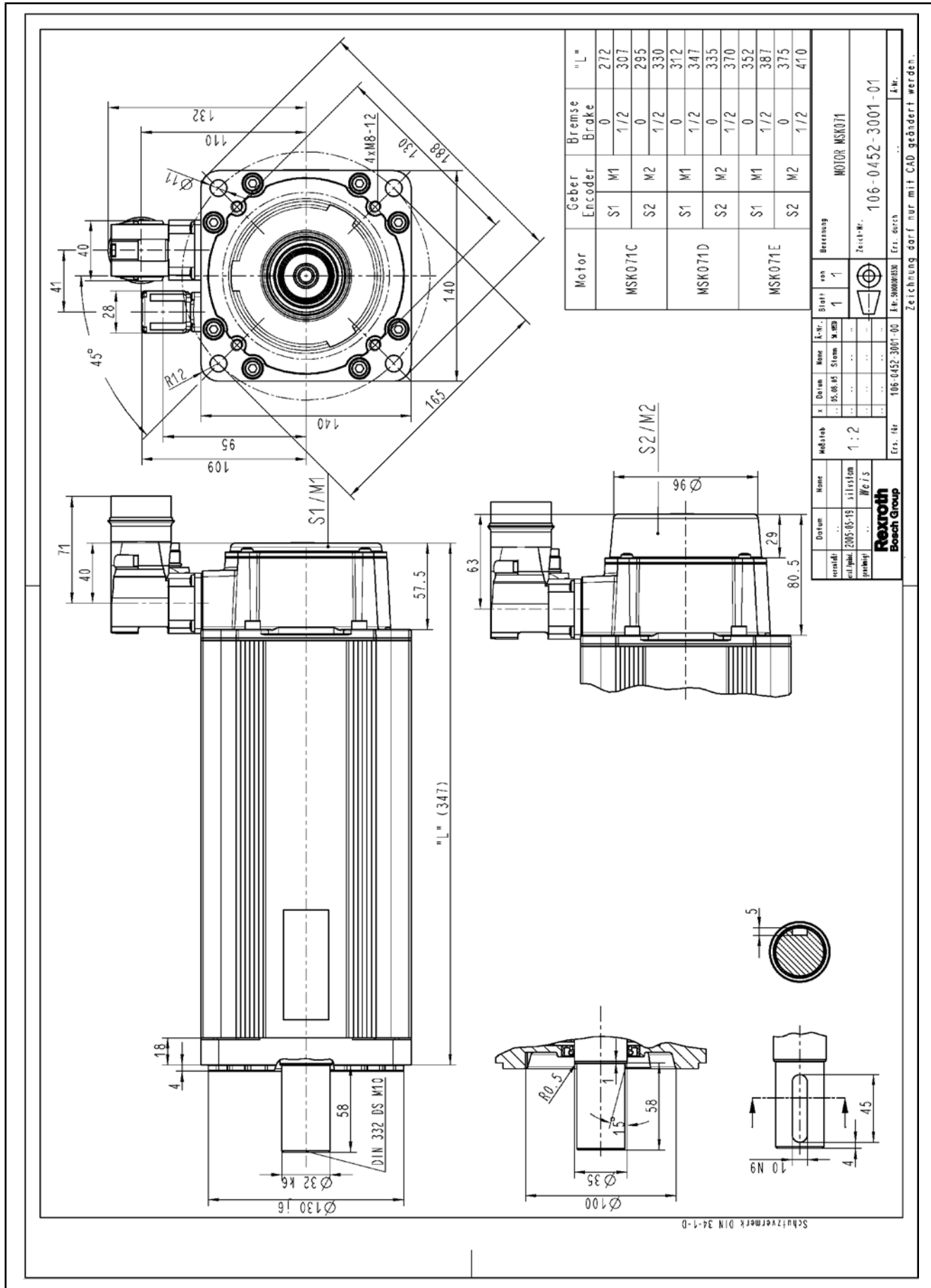

Fig.5-9: MSK071...NN specification

5.9 Size MSK071 with Liquid Coolant

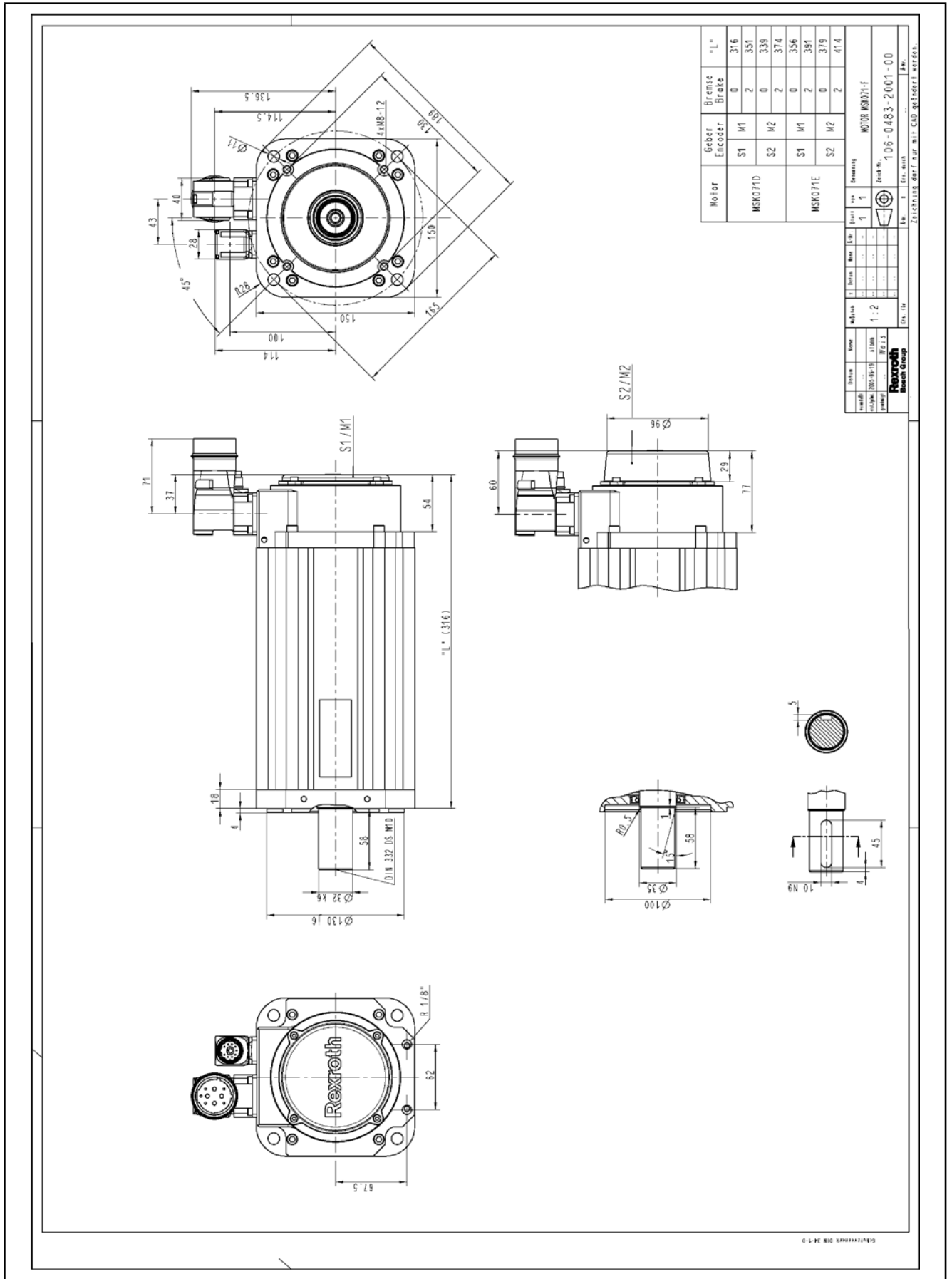

Fig.5-10: MSK071...FN specification

5.11 Size MSK100

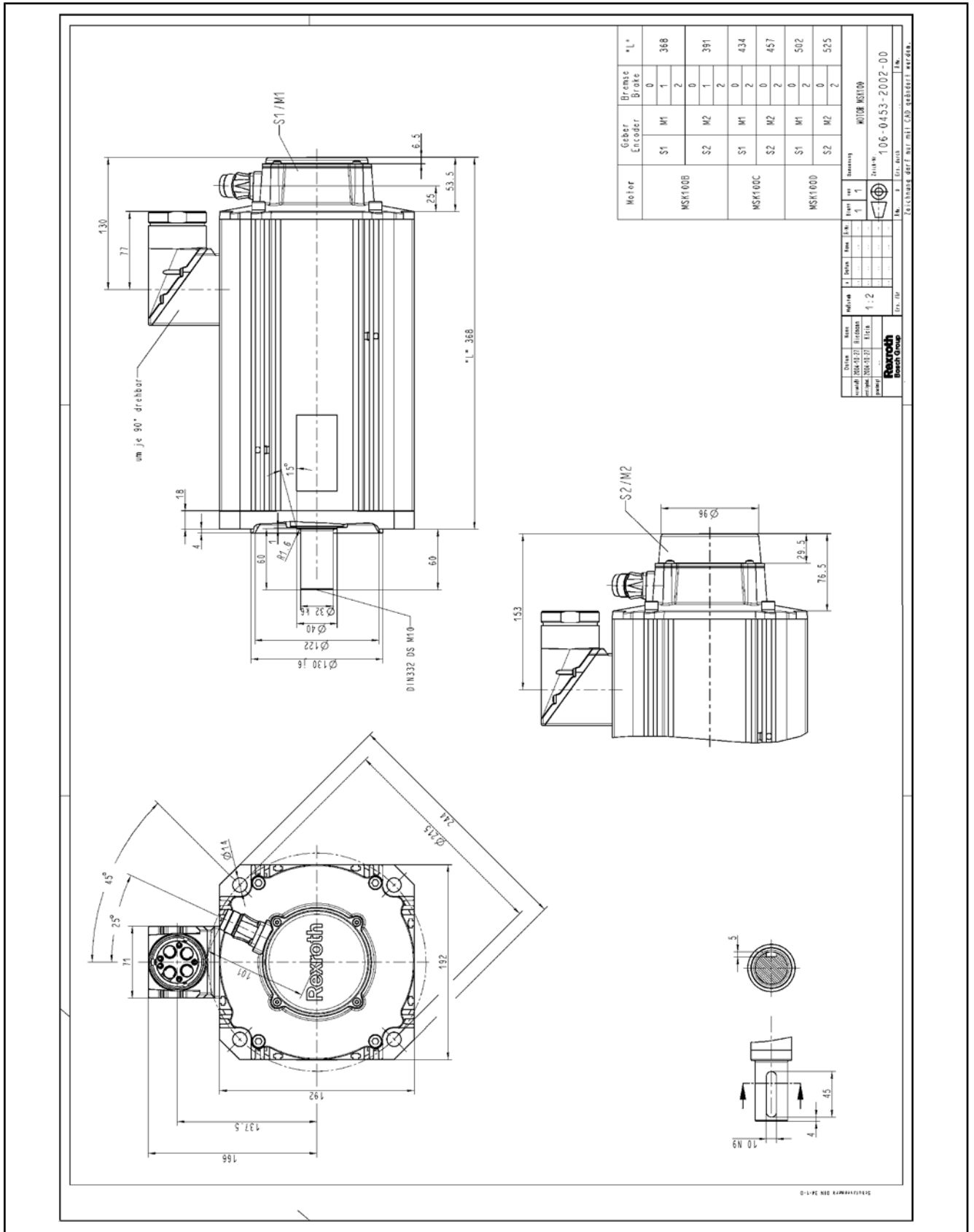

Fig.5-12: MSK100 specification

Specifications

5.12 Size MSK101

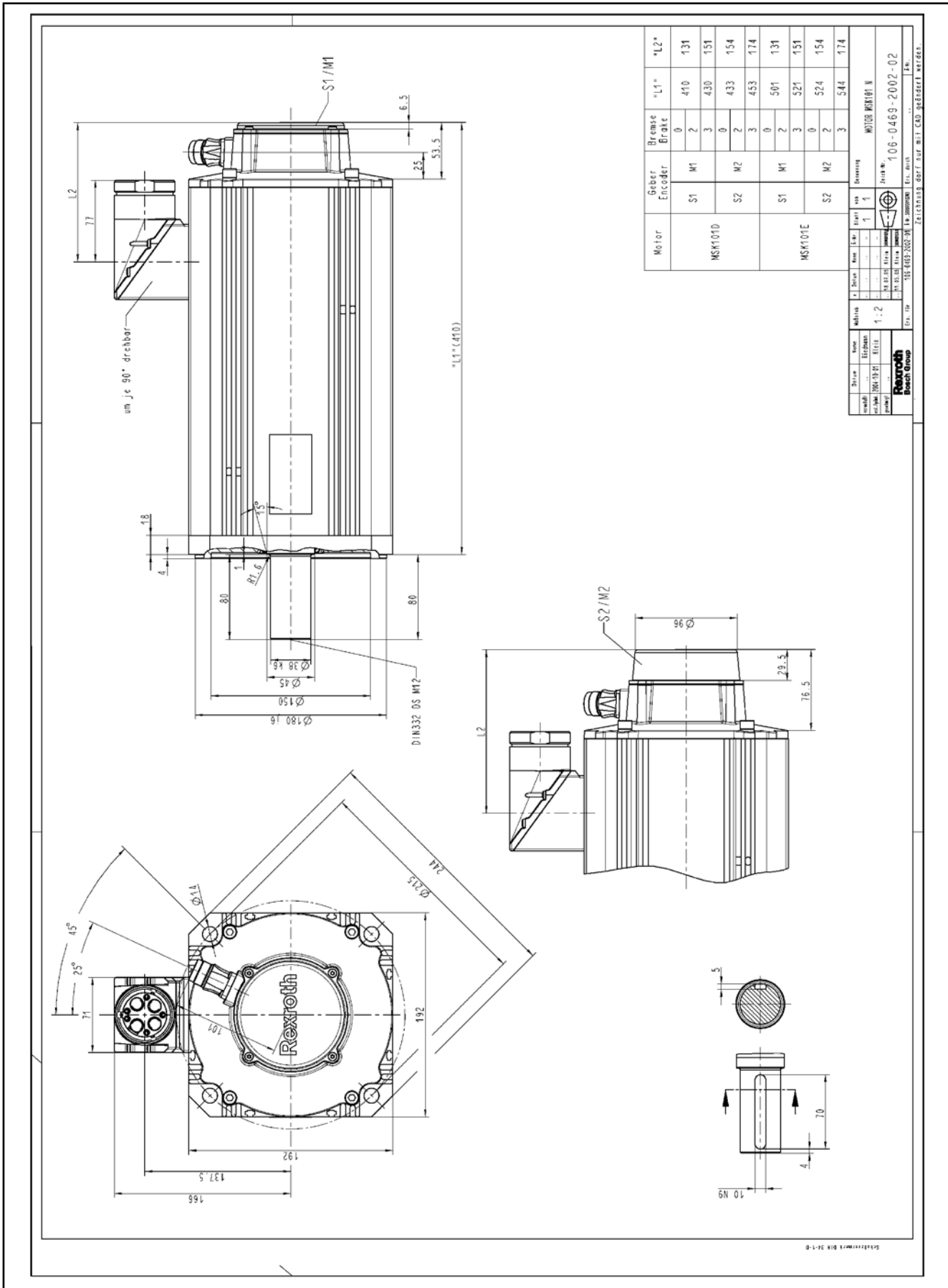

Fig.5-13: MSK101 specification

5.13 Size MSK101 with Liquid Cooling

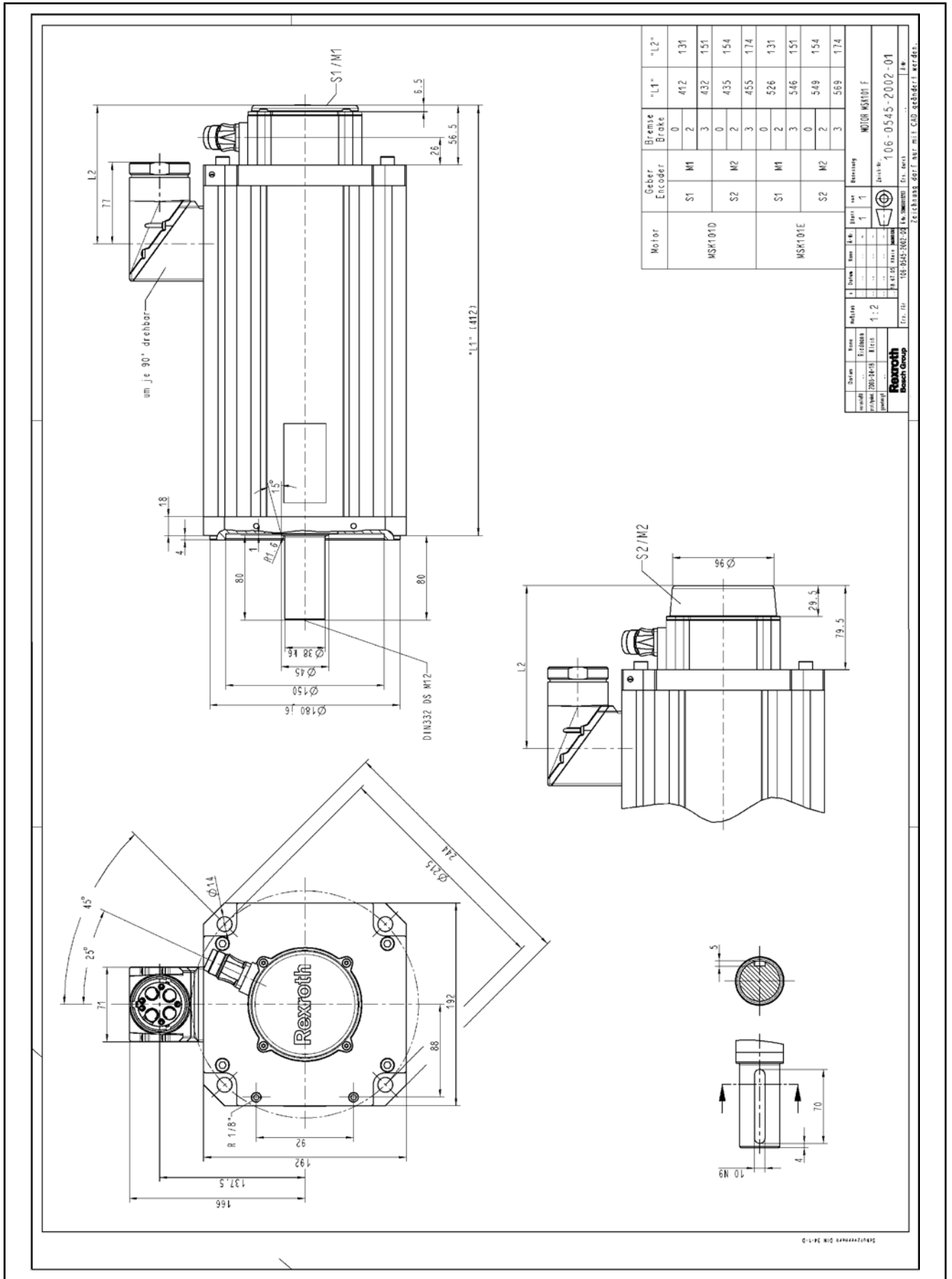

Fig.5-14: MSK101...FN specification

6 Type Codes

6.1 Description

General Each order of a Rexroth product must be based on the type code. All available motor variants are uniquely described by their type code. The individual characters of the type code (abbrev. column) and their meaning are described below.



- The sections below are numbered according to the numbering of the individual type codes.
- Before ordering, please check the availability of the separate options with your Bosch Rexroth sales partner.

Product

Abbrev.-Column	1	2	3	4	5	6	7	8	9	0	1	2	3	4	5	6	7	8	9	0	1	2	3	4	5	6	7	8	9
Example	M	S	K	0	7	0	C	-	0	4	5	0	-	N	N	-	S	1	-	U	G	0	-	N	S	N	N		

1. **Product**

Fig.6-1: Type code column

MSK three-digit Rexroth-specific designation of a servomotor series.

Frame size

Abbrev.-Column	1	2	3	4	5	6	7	8	9	0	1	2	3	4	5	6	7	8	9	0	1	2	3	4	5	6	7	8	9
Example	M	S	K	0	7	0	C	-	0	4	5	0	-	N	N	-	S	1	-	U	G	0	-	N	S	N	N		

2. **Motor size**

Fig.6-2: Type code column

The motor frame size determines important mechanical motor specifications and is proportional to the performance variables. In addition, column 6 indicates a difference in the rotor moments of inertia.

- 0 Normal rotor moment of inertia
- 1 Normal rotor moment of inertia

Frame length

Abbrev.-Column	1	2	3	4	5	6	7	8	9	0	1	2	3	4	5	6	7	8	9	0	1	2	3	4	5	6	7	8	9
Example	M	S	K	0	7	0	C	-	0	4	5	0	-	N	N	-	S	1	-	U	G	0	-	N	S	N	N		

3. **Motor length**

Fig.6-3: Type code column

Within a series, the graduation of increasing motor frame length is indicated by ID letters in alphabetic order. Frame lengths are, for example, B, C, D and E.

Winding

Abbrev.-Column	1	2	3	4	5	6	7	8	9	0	1	2	3	4	5	6	7	8	9	0	1	2	3	4	5	6	7	8	9
Example	M	S	K	0	7	0	C	-	0	4	5	0	-	N	N	-	S	1	-	U	G	0	-	N	S	N	N		

4. **Windings code**

Fig.6-4: Type code column

The four-digit sequence of figures identifies the rated speed applicable for the respective type of winding.

Type Codes

Type of Cooling

Abbrev.-Column	1	2	3	4	5	6	7	8	9	1	2	3	4	5	6	7	8	9	2	1	2	3	4	5	6	7	8	9
Example	M	S	K	0	7	0	C	-	0	4	5	0	-	N	N	-	S	1	-	U	G	0	-	N	S	N	N	-
Cooling mode																												

Fig.6-5: Type code column

Option	Design	Detail
NN	Natural Convection	Fan mounting possible
FN	Liquid cooling	Standard connection for coolant ducts 1/8", fan mounting not possible

Fig.6-6: Cooling modes for IndraDyn S motors

Encoder

Abbrev.-Column	1	2	3	4	5	6	7	8	9	1	2	3	4	5	6	7	8	9	2	1	2	3	4	5	6	7	8	9
Example	M	S	K	0	7	0	C	-	0	4	5	0	-	N	N	-	S	1	-	U	G	0	-	N	S	N	N	-
6. Encoder																												

Fig.6-7: Type code column

IndraDyn S motors are equipped with an integrated encoder system. To control the motor speed and/or to position the motor, the drive controller requires information on the current motor position.

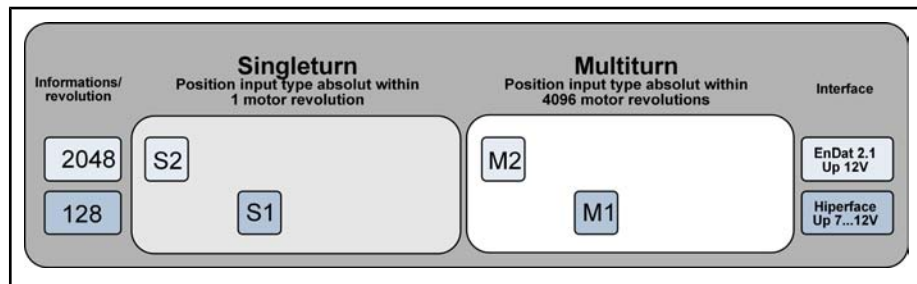

Fig.6-8: IndraDyn S motor encoders

Electrical Connection

Abbrev.-Column	1	2	3	4	5	6	7	8	9	1	2	3	4	5	6	7	8	9	2	1	2	3	4	5	6	7	8	9
Example	M	S	K	0	7	0	C	-	0	4	5	0	-	N	N	-	S	1	-	U	G	0	-	N	S	N	N	-
7. Electrical connection																												

Fig.6-9: Type code column

Option U

MSK030, -040, -050, -060, -070 and -071 motors are equipped with rotatable plugs to connect encoders and the power supply.

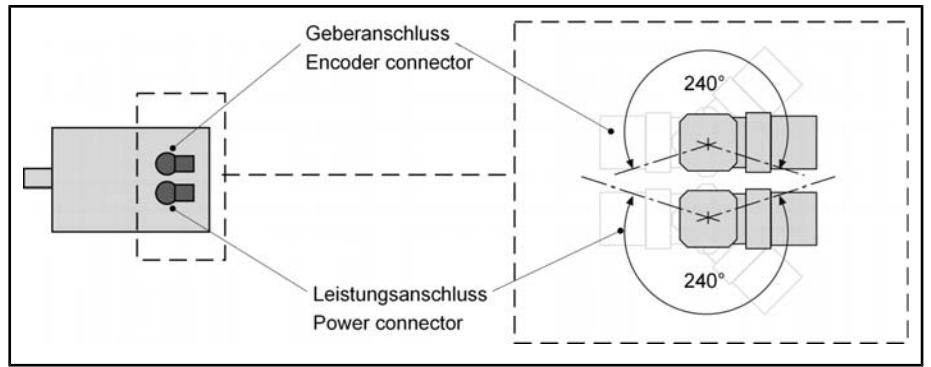

Fig.6-10: IndraDyn S rotating plugs

Options A, B, L or R

Motors with frame size MSK100 are available with determined output directions only.

Option	Description
A	Output connector in direction of side A
B	Output connector in direction of side B
L	Power connector to the left
R	Power connector to the right

Fig.6-11: IndraDyn S connectors with fixed output direction

Drive shaft

Abbrev.-Column	1	2	3	4	5	6	7	8	9	0	1	2	3	4	5	6	7	8	9	0	1	2	3	4	5	6	7	8	9							
Example	M	S	K	0	7	0	C	-	0	4	5	0	-	N	N	-	S	1	-	U	G	-	N	S	N	N										
8. Shaft																																				

Fig.6-12: Type code column

In order to connect the machine elements to be driven to the motor drive shafts, the following options are available for all IndraDyn S motors:

Option	Design	Detail
G	Plain shaft	With frontal centering hole with "DS" thread according to DIN 332, Part 2, Edition 05.83
P	Shaft with keyway ¹⁾	

1) Keyway according to DIN 6885, Sheet 1, ed. 08.68. For details, refer to the dimension sheets.

Fig.6-13: IndraDyn S drive shafts



IndraDyn S motors are balanced with a key. The pertinent key is not included in the scope of delivery.

Holding brake

Abbrev.-Column	1	2	3	4	5	6	7	8	9	0	1	2	3	4	5	6	7	8	9	0	1	2	3	4	5	6	7	8	9							
Example	M	S	K	0	7	0	C	-	0	4	5	0	-	N	N	-	S	1	-	U	G	0	-	N	S	N	N									
9. Holding brake																																				

Fig.6-14: Type code column

Type Codes

As an option, IndraDyn S motors are available with electrically-released holding brakes with various holding torques.

Option	Holding Brakes	
0	Without holding brake	
1, 2, 3	With holding brake	Please refer to the motor type codes for the holding torques.

Fig.6-15: IndraDyn S holding brakes



The holding brake is not suitable for the protection of personnel or as a service brake! Please also observe the installation and safety instructions on the motor holding brakes in the chapter entitled "Application Instructions".

Design

Abbrev.- Column	1									2																		
	1	2	3	4	5	6	7	8	9	0	1	2	3	4	5	6	7	8	9									
Example	M	S	K	0	7	0	C	.	0	4	5	0	.	N	N	.	S	1	.	U	G	0	.	N	N	N	N	.
10. Other design	_____																											

Fig.6-16: Type code column

NNNN = default model

NSNN = Standard and ATEX design according to Group II, Categories 3G and 3D according to DIN EN 60079 ff.

RNNN = design with increased concentricity

RSNN = Design with increased concentricity and ATEX design according to Group II, Categories 3G and 3D according to DIN EN 60079 ff.



You can find precise descriptions of motors in ATEX design in the documentation DOK-MOTOR*-MSK*EXGIK3-PRxx-EN-P. If required, order this documentation at your responsible Rexroth sales office.

Reference to Standards

The item "Reference to standards" indicates standards referred to in the type code (e.g. DIN, EN, ISO, etc.) or factory standards (RNC ...) that are also applicable. The version listed is always that valid at the time the type code is issued.

Comment

Please refer to this item for additionally required information concerning the handling of the type code. This includes, for example, descriptions on footnotes or notes on availability.

7 Accessories and Options

7.1 Motor Encoder

7.1.1 General

To control the motor speed and/or to position the motor, the drive controller requires information on the current rotor position.

To achieve this, the integrated encoder unit makes the appropriate signals available to the drive controller. The drive control devices can transfer the position value determined in this manner to a superordinate controller.

The encoder electronics are equipped with a data memory where the motor type name, the control loop parameters and the motor parameters are filed. Rexroth drive control devices read out these data. This ensures

- quick and easy startup,
- adaptation between the motor and the drive controller without the risk of damage to the motor.

7.1.2 Motor Encoder Technical Data

Option	Encoder type	Measuring method	System accuracy	Position recording type	Position resolution on the motor
S1	Singleturn Hiper-face optical encoder	Optically	± 80 angular seconds	Absolute (more than 1 motor revolutions)	$128 \times 2^{13} = 1,048,576$ bits of information / revolution
M1	Multiturn absolute optical encoder			Absolute (more than 4096 motor revolutions)	
S2	Optical encoder singleturn EnDat 2.1	Optically	± 20 angular seconds	Absolute (more than 1 motor revolutions)	$2048 \times 2^{13} = 16,777,216$ bits of information / revolution
M2	Optical encoder multiturn absolute EnDat 2.1			Absolute (more than 4096 motor revolutions)	

Fig.7-1: Motor Encoder Technical Data

Singleturn optical encoder Option S1, S2

These encoders permit absolute, indirect position recording within **one** mechanical rotation. The encoders replace a separate incremental encoder on the motor.



After a power failure or after the first POWER ON, the axis must first always be moved to its home position.

Exception: Applications in which the maximum working path is within one mechanical rotation of the motor.

Multiturn absolute optical encoder Option M1, M2

These encoders permit absolute, indirect position recording within **4096** mechanical rotations. The encoders replace a separate absolute value encoder on the motor. With this encoder version, the absolute position of the axis is preserved even after voltage switch-off.

Accessories and Options

7.2 Holding Brakes

In **normal operation**, use the brake only when at a standstill and when performing the drive-internal brake check. The holding brake is required for holding the axle when the machine is in a de-energized state.

When using holding brakes, observe the additional information in [chapter 9.9 "Holding Brakes"](#) on page 167 and [chapter 12.4.5 "Holding Brakes"](#) on page 185.



For technical data and availability of holding brakes see chapters "Technical data" and "Type codes".

7.3 Fan Units for MSK Motors

7.3.1 Technical Data

Type	Protection class	U _N [V]	f _N [Hz]	I _N [A]	m _L [kg]	L _p [dB(A)]
LEM-AB-116N-11-NNNN	IP 65	115 ±10%	60	0,48	2,3	<75
LEM-AB-116N-21-NNNN	IP 65	230 ±15%	50	0,19	2,3	<75
LEM-AB-140N-11-NNNN	IP 65	115 ±10%	60	0,48	3,7	<75
LEM-AB-140N-21-NNNN	IP 65	230 ±15%	50	0,19	3,7	<75
LEM-AB-192N-11-NNNN	IP 65	115 ±10%	60	0,45	4,25	<75
LEM-AB-192N-21-NNNN	IP 65	230 ±15%	50	0,2	4,25	<75

Fig.7-2: Technical data of fan unit

7.3.2 Assignment

- Select the required fan unit for the motor type from the following table.



The complete type code is not necessary to select a motor. The fan unit is identically within a motor frame size.

	LEM-AB-116N-11-NNNN	LEM-AB-116N-21-NNNN	LEM-AB-140N-11-NNNN	LEM-AB-140N-21-NNNN	LEM-AB-192N-11-NNNN	LEM-AB-192N-21-NNNN
MSK060B, -C	■	■				
MSK070C, -D			■	■		
MSK071D, -E			■	■		
MSK100B, -C, -D					■	■
MSK101D, -E					■	■

Fig.7-3: Matrix to select the motor - fan unit

7.3.3 Electrical Connection, Adjust Motor Protection

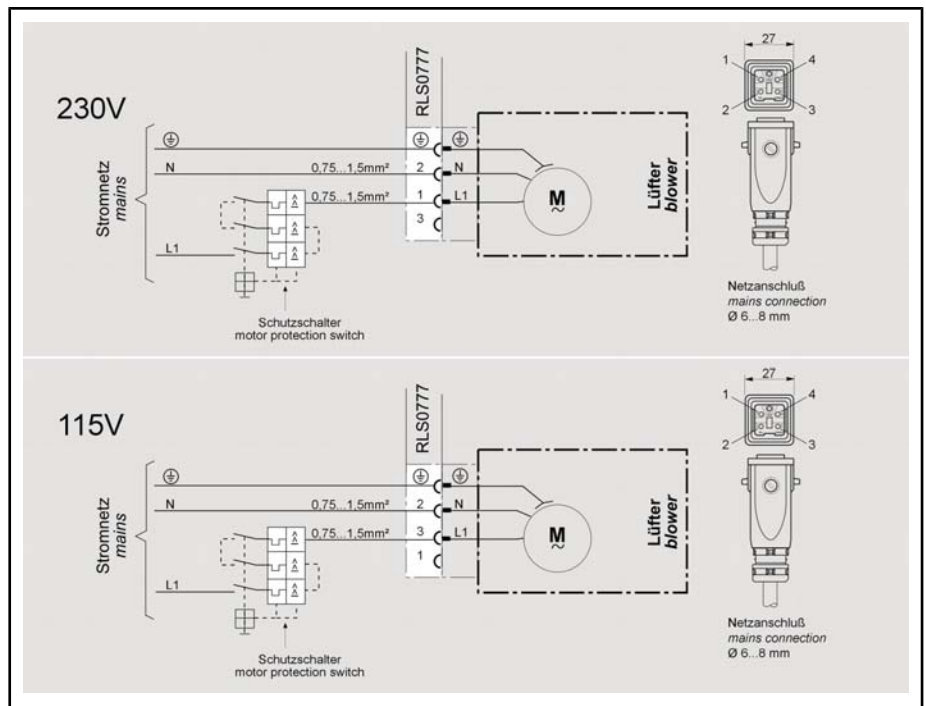

Fig.7-4: Fan connection 1-phase with circuit breaker



Protect from wrong connection!

- 230V: L1 auf Pin 1
- 115V: L1 auf Pin 3



WARNING

Fire danger! Improper temperature-rise of the motor cable due to motor current.

⇒ dimension the power cable correctly, select the cross-section according to the motor current

Fusing due to the motor circuit breaker

The connection of the fan units is to be done by adjustable motor protective equipment.

The active principle of the motor circuit breaker is based on the motor current-carrying bimetal-actuator, which heats-up faster than the motor winding and disconnects it from the supply system before critical temperature values can be reached.

The motor circuit breakers are adjusted with reference to the rated current of the fan unit. Observe, when selecting the motor circuit breaker that the adjustment range corresponds with the rated current of the fan unit.

7.3.4 Ordering

Motor with attached fan unit

In order to procure a motor with attached surface-cooling, the type name of the fan unit must be specified as an ordering subitem of the motor with the fan arrangement desired.

Accessories and Options

Ordering item	Ordering name
1	Synchronous motor MSK100B-0300-NN-S1-BG1-NNNN
1.1	Fan unit LEM-AB-192N-11-NNNN, mounted on Pos. 1 fan arranged on the left side

Fig.7-5: Ordering data for a motor with attached fan unit

Motor with separate fan unit

If it is specified as an independent ordering item, the fan unit is supplied separately from the motor (i.e. not attached to the latter).

Ordering item	Ordering name
1	Synchronous motor MSK100B-0300-NN-S1-BG1-NNNN
2	Fan unit LEM-AB-192N-11-NNNN

Fig.7-6: Ordering data for a motor with separate fan unit

MSK101 fan unit axial

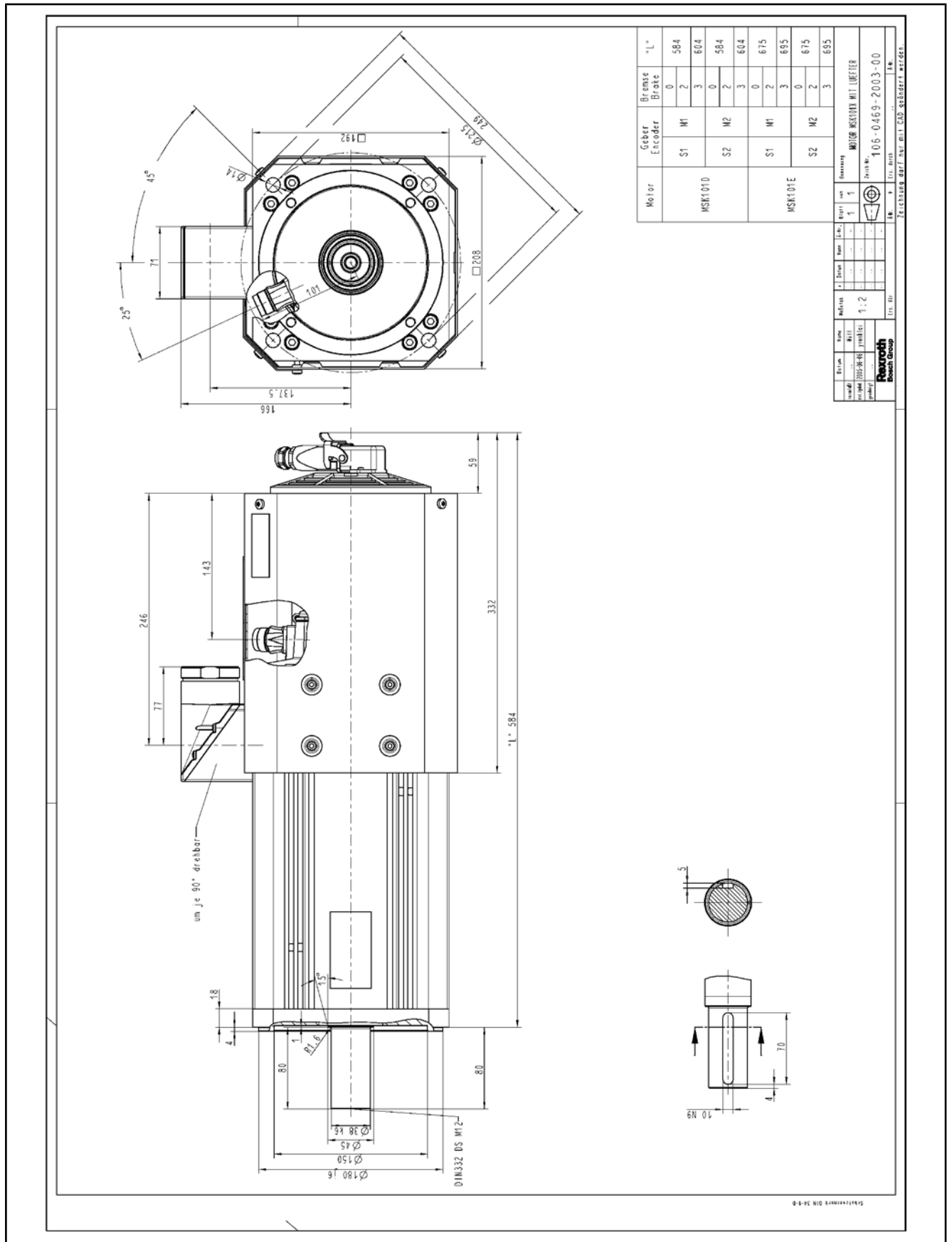

Fig.7-11: Dimension sheet MSK101 with axial fan unit

Accessories and Options

7.3.6 Assembly

Fan unit LEM-AB-116N

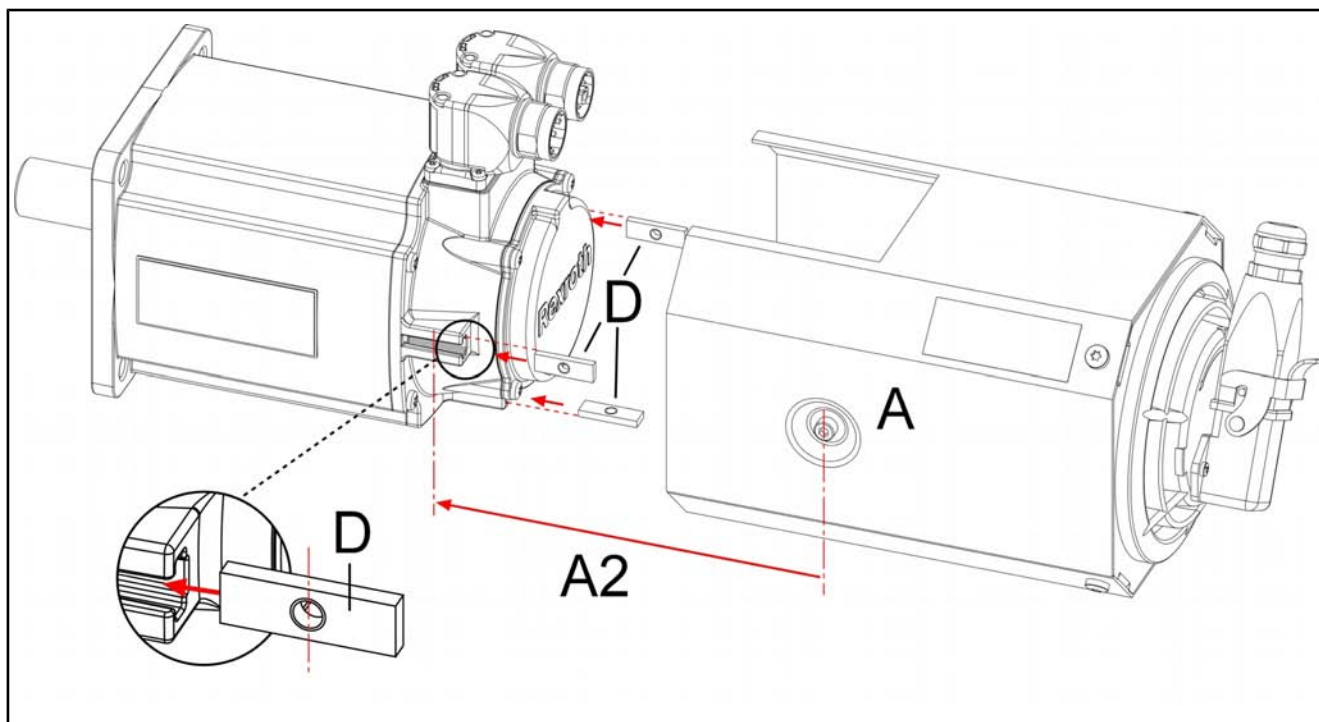
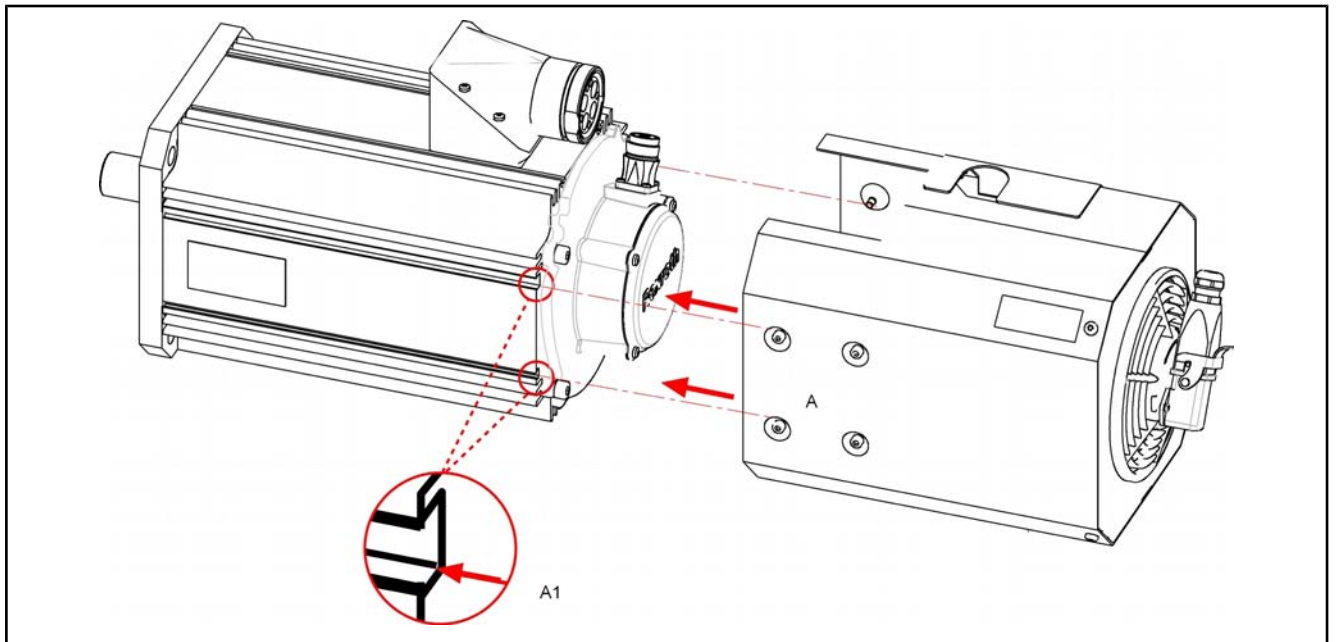

Fig.7-12: Assembly of fan unit LEM-AB-116N-xx-NNNN

Mounting procedure

1. Insert the terminal block D into the groove of the end shield.
2. Insert the fan unit as far as (A2) it will go onto the end shield.
3. Tighten the fastening screws A. Tightening torque 4 Nm.
4. Electrical connection according to the connection diagram.

Fan unit LEM-AB-140N



- A Fastening screws of the fan unit
A1 Insert the fastening rail into the motor
Fig.7-13: Assembly of fan unit LEM-AB-140N-xx-NNNN

Mounting procedure

1. Loosen the fastening screws A on both sides and insert the fan unit onto the motor housing.
2. Tighten the fastening screws A. Tightening torque 4 Nm.
3. Electrical connection according to the connection diagram.

Accessories and Options

Fan unit LEM-AB-192N

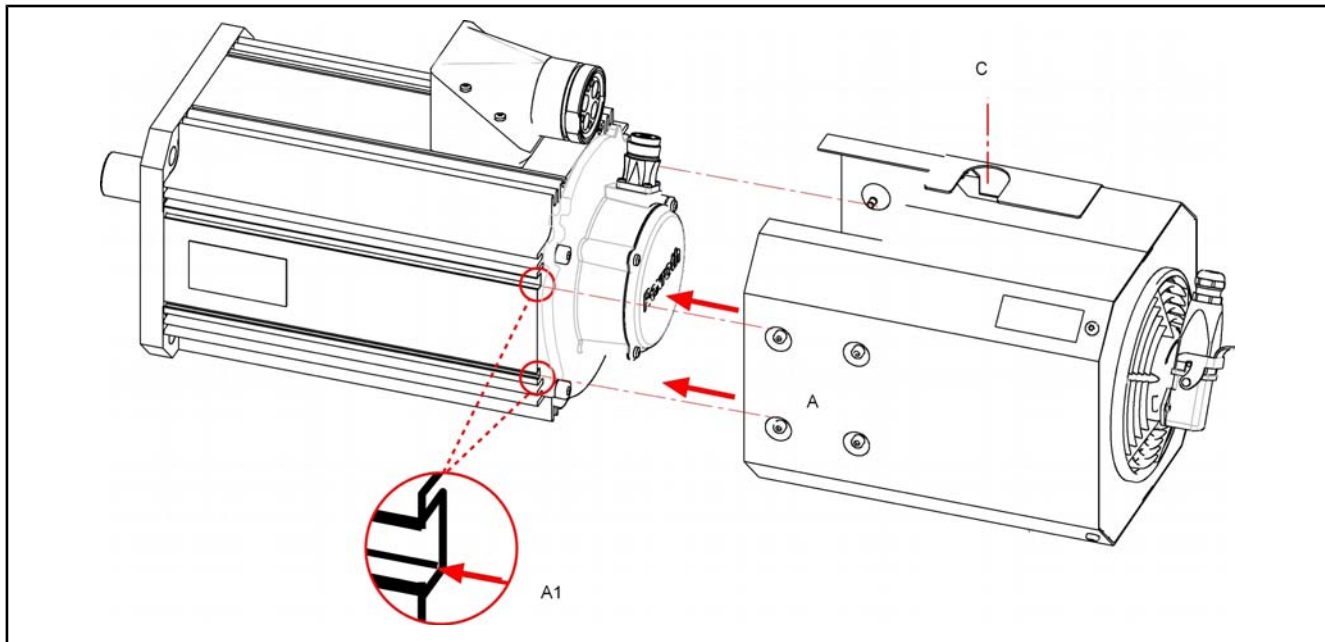

A Fastening screws of the fan unit
 A1 Insert the fastening rail into the motor
 C Cover sheet for encoder connector
 Fig.7-14: Assembly of fan unit LEM-AB-192N-xx-NNNN

Mounting procedure

1. Loosen the fastening screws A on both sides and insert the fan unit onto the motor housing.
2. Tighten the fastening screws A. Tightening torque 4 Nm.
3. Electrical connection according to the connection diagram.
4. Open the cover C, pass the encoder cable through and connect the encoder connector.

7.4 Gearbox

Gearboxes of the series

- GTM
- GTE

are optimally tuned to the motor series of IndraDyn S. The technical data, as well as the various transformation ratios, are described in detailed documentation.

You can order product documentation about gearboxes with the following ordering designation at your responsible sales office.

DOK-GEAR-GTE*****-PRxx-EN-P**

DOK-GEAR-GTM*****-PRxx-EN-P**

7.5 Sealing Air Connection

Function, description The accessory set SUP-M01-MSK allows a defined excess pressure to be introduced into the interior of the motor. This procedure reliably prevents damaging fluids from penetrating through sealing points that are at risk. The areas

Conditions, requirements

of application for sealing air are all installation locations in which humid air or coolant can come into direct contact with the motors, especially in wet rooms.

In order to use sealing air in IndraDyn S motors, the system must have a compressed air connection. The required compressed air preparation system and the hoses for the compressed air must be provided by the customer.



Observe the stated operating pressure for motors!

Technical Data

Description	Symbol	Unit	MSK030 MSK040 MSK061 MSK071 MSK076 MSK100 MSK101
Working pressure	p	bar	0,1 ... 0,2
Max. relative air humidity	ϕ	%	20 ... 30
Air			dustfree
			oil-free

Fig.7-15: Technical data for IndraDyn S sealing air connection

Ordering designations and assignment

Select the required sealing air accessory for the motor type from the following table.

	SUP-M01-MSK Sealing air connection R911306562	SUP-M02-MSK Sealing air connection R911315974
MSK030	■	
MSK040	■	
MSK061	■	
MSK071	■	
MSK076	■	
MSK100		■
MSK101		■

Fig.7-16: Matrix to select the sealing air accessory

Accessories and Options

Mounting instructions **Retrofitting of IndraDyn S - SUP-M01-MSK**

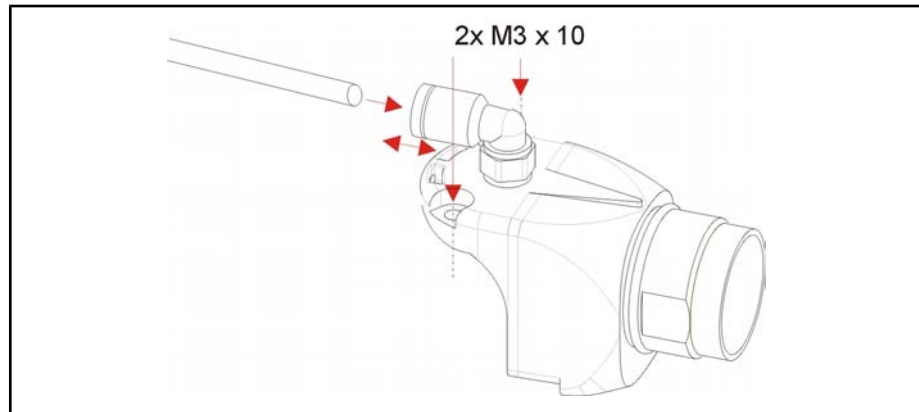

Fig.7-17: RLS1000 with sealing air connection



Death by electrocution possible due to live parts with more than 50V!

⇒ Open the machine sockets of the motor only when the system has been de-energized!

1. Open the main switch
2. Ensure that the main switch cannot be accidentally switched on again
3. Loosen the screws of the encoder plug cover and remove the cover.
4. Assemble the sealing air connection.



When positioning the cover, ensure that the cable wires and seals are not damaged.

Screw the encoder plug cover with the sealing air connection onto the motor. Torque of the screws = 1.3 Nm.

5. Connect the quick-acting pneumatic coupling of the accessory set to the regulated compressed air source.

The sealing air unit is now ready for operation.

Mounting instructions **Retrofitting of IndraDyn S - SUP-M02-MSK**

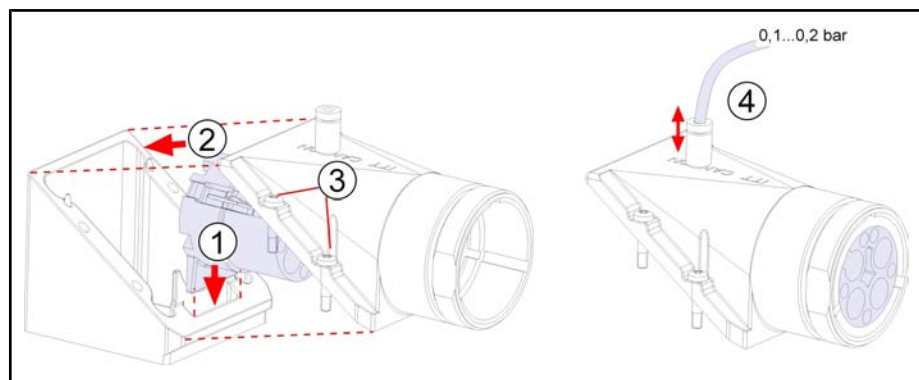

Fig.7-18: RLS1300 with sealing air connection

**DANGER**

Death by electrocution possible due to live parts with more than 50V!

⇒ Open the machine sockets of the motor only when the system has been de-energized!

-
1. Open the main switch
 2. Ensure that the main switch cannot be accidentally switched on again
 3. Loosen the screws of the power plug cover and remove the cover.
 4. Assemble the sealing air connection.



When positioning the cover, ensure that the cable wires and seals are not damaged.

Screw the power plug cover with the sealing air connection onto the motor.
Torque of the screws = 1.3 Nm.

5. Connect the quick-acting pneumatic coupling of the accessory set to the regulated compressed air source.

The sealing air unit is now ready for operation.

8 Connection Techniques

8.1 General

The electrical connections of IndraDyn S motors are standardized over all frame sizes. IndraDyn S motors are provided with

- a power connector, incl. connection for temperature sensor and holding brake,
- an encoder connection.

Both connectors are designed as plug connections. When ready-made Rexroth connection cables are used, this ensures simple, fast and error-free assembly and commissioning.

The connection diagram applies to all IndraDyn S motors.

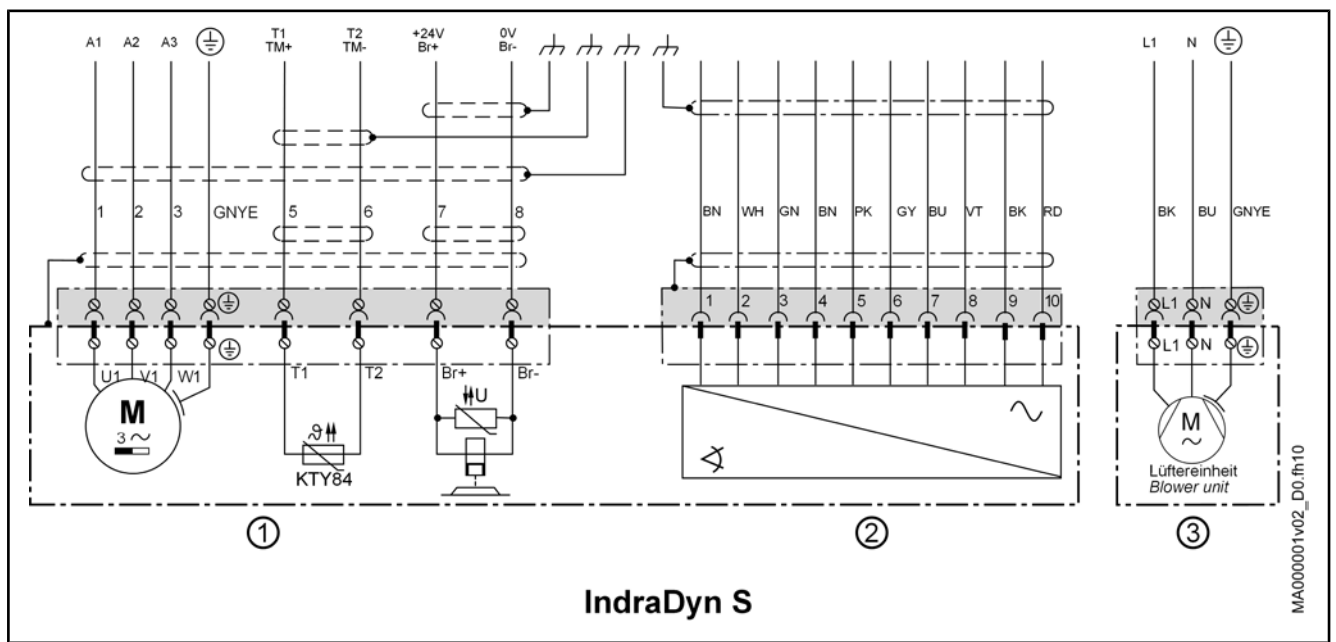

- ① Power connection with temperature sensor and holding brake
- ② Encoder Connection
- ③ Fan connection(optional)

Fig.8-1: Overview of IndraDyn S connections

MA000001v02_D0.fh10

Connection Techniques

8.2 Power Connector Size 1

8.2.1 RLS1100 Flange Socket

In motors of frame size **MSK030**, **MSK040**, **MSK050**, **MSK060**, the power is supplied using a flange socket RLS1100.

Graphical representation

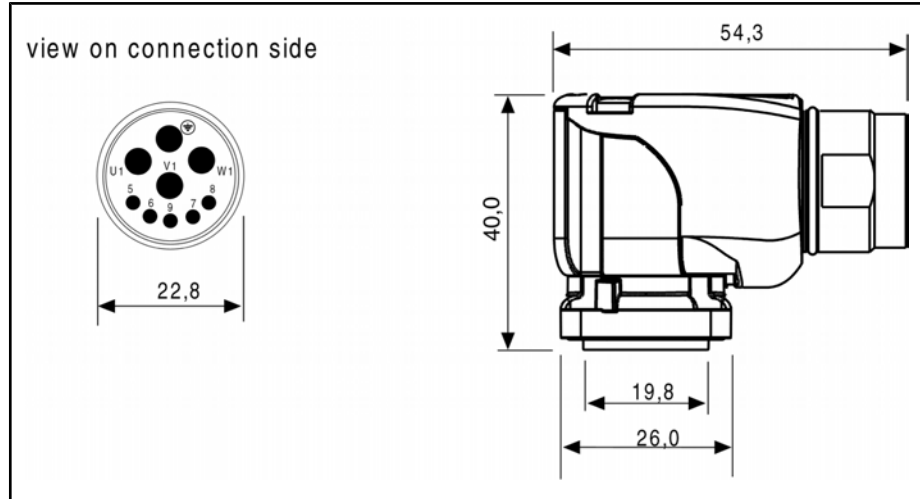

Fig.8-2: RLS1100 Flange Socket

Mechanical data

Protection class	Number of pins	Temperature range	Contact type
IP66 / IP67 plugged	3 + PE + 5	-40 °C to +125 °C	Pin

Fig.8-3: Mechanical data

Electrical data

Rated voltage	Continuous rated current	Degree of pollution	Overtoltage category
630 V / 125 V	16 A	3	III (according to DIN VDE 0110)

Fig.8-4: Electrical data

Contact assignment

U1	Power	
V1	Power	
W1	Power	
PE	Grounding	
5	Temperature sensor KTY84 (T1 TM+)	
6	Temperature sensor KTY84 (T2 TM-)	
7	Holding brake (Br+ / +24V)	Option
8	Holding brake (Br- / 0V)	
9	n.c.	

Fig.8-5: RLS1100 – contact assignment for MSK motors

8.2.2 RLS1101 Power Connector

The power plug RLS1101 is used as a motor connection plug for motors MSK030, MSK040, MSK050, MSK060, and as a power coupling.

Graphical representation

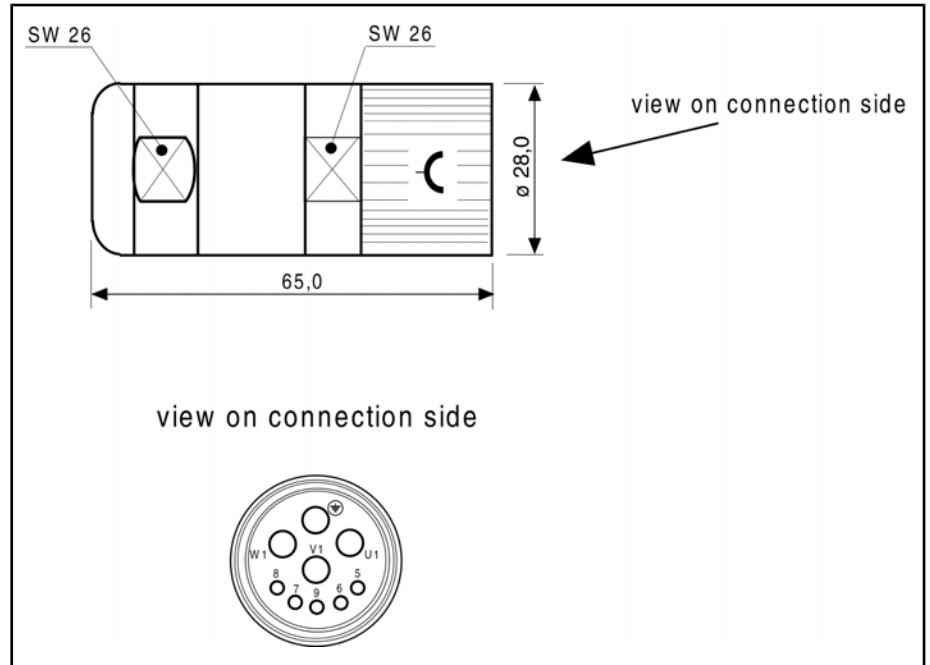

Fig.8-6: Plug RLS1101

Mechanical data

Protection class	Number of pins	Temperature range	Contact type
IP66 / IP67 plugged	3 + PE + 5	-40 °C to +125 °C	Socket

Fig.8-7: Mechanical data

Electrical data

Rated voltage	Continuous rated current	Degree of pollution	Overvoltage category
630 V / 125 V	16 A	3	III (according to DIN VDE 0110)

Fig.8-8: Electrical data

Contact assignment

U1	Power	
V1	Power	
W1	Power	
PE	Grounding	
5	Temperature sensor KTY84 (T1 TM+)	
6	Temperature sensor KTY84 (T2 TM-)	
7	Holding brake (Br+ / +24V)	Option
8	Holding brake (Br- / 0V)	
9	Brake / temp. shield	

Fig.8-9: RLS1101 – contact assignment for MSK motors

Connection Techniques

Order designation for plugs

Ordering type	Power wire cross-section	Terminal area, outer cable diameter [mm]
RLS1101/C02	1,0 / 1,5	11,0 – 14,0

Fig.8-10: Order designation for RLS1101 plug

8.3 Power Connector Size 1.5

8.3.1 RLS1200 Flange Socket

In motors of frame size **MSK070, MSK071**, the power is supplied by using a flange socket RLS1200.

Graphical representation

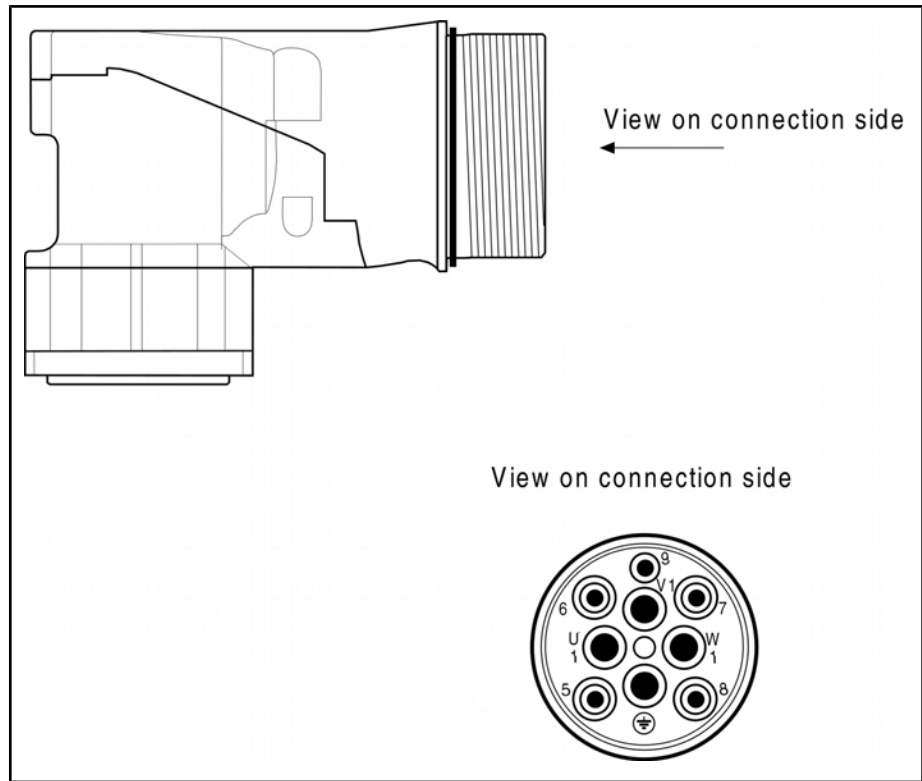

Fig.8-11: Flange Socket RLS1200

Mechanical data

Protection class	Number of pins	Temperature range	Contact type
IP66 / IP67 plugged	3 + PE + 5	-40 °C to +125 °C	Pin

Fig.8-12: Mechanical data

Electrical data

Rated voltage	Continuous rated current	Degree of pollution	Overvoltage category
630 V / 125 V	max. 57.0 A depending from the wire cross-section	3	III (according to DIN VDE 0110)

Fig.8-13: Electrical data

Contact assignment

U1	Power	
V1	Power	
W1	Power	
PE	Grounding	
5	Temperature sensor KTY84 (T1 TM+)	
6	Temperature sensor KTY84 (T2 TM-)	
7	Holding brake (Br+ / +24V)	Option
8	Holding brake (Br- / 0V)	
9	n.c.	

Fig.8-14: RLS1200 – contact assignment for MSK motors

8.3.2 RLS1201 Power Connector

The flange socket RLS1201 is used as a connection for **MSK070**, **MSK071** motors and as a power coupling.

Graphical representation

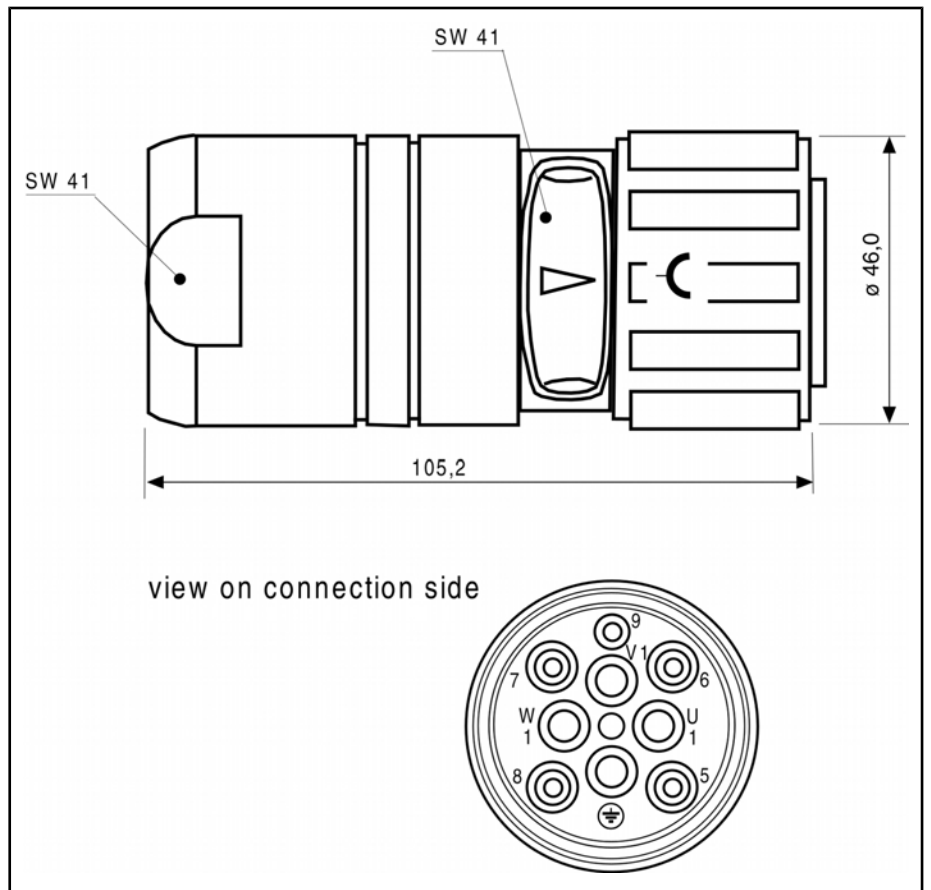

Fig.8-15: Plug RLS1201

Mechanical data

Protection class	Number of pins	Temperature range	Contact type
IP66 / IP67 plugged	3 + PE + 5	-40 °C to +125 °C	Socket

Fig.8-16: Mechanical data

Connection Techniques

Electrical data

Rated voltage	Continuous rated current	Degree of pollution	Overtoltage category
630 V / 125 V	max. 57.0 A depending from the wire cross-section	3	III (according to DIN VDE 0110)

Fig.8-17: Electrical data

Contact assignment

U1	Power	
V1	Power	
W1	Power	
PE	Grounding	
5	Temperature sensor KTY84 (T1 TM+)	
6	Temperature sensor KTY84 (T2 TM-)	
7	Holding brake (Br+ / +24V)	Option
8	Holding brake (Br- / 0V)	
9	Brake / temp. shield	

Fig.8-18: RLS1201 – contact assignment for MSK motors

Order designation for plugs

Ordering type	Power wire cross-section	Terminal area, outer cable diameter [mm]
RLS1201/C02	1,5	9,0 – 12,7
RLS1201/C04	2,5 / 4,0	13,0 – 17,3
RLS1201/C06	6,0	17,5 – 21,5
RLS1201/C10	10,0	21,5 – 26,0

Fig.8-19: Order designation for RLS1201 plug

8.4 Power Connector Size 2

8.4.1 RLS1300 Flange Socket

In motors of frame size MSK100, MSK101 the power is supplied using flange socket RLS1300.

Graphical representation

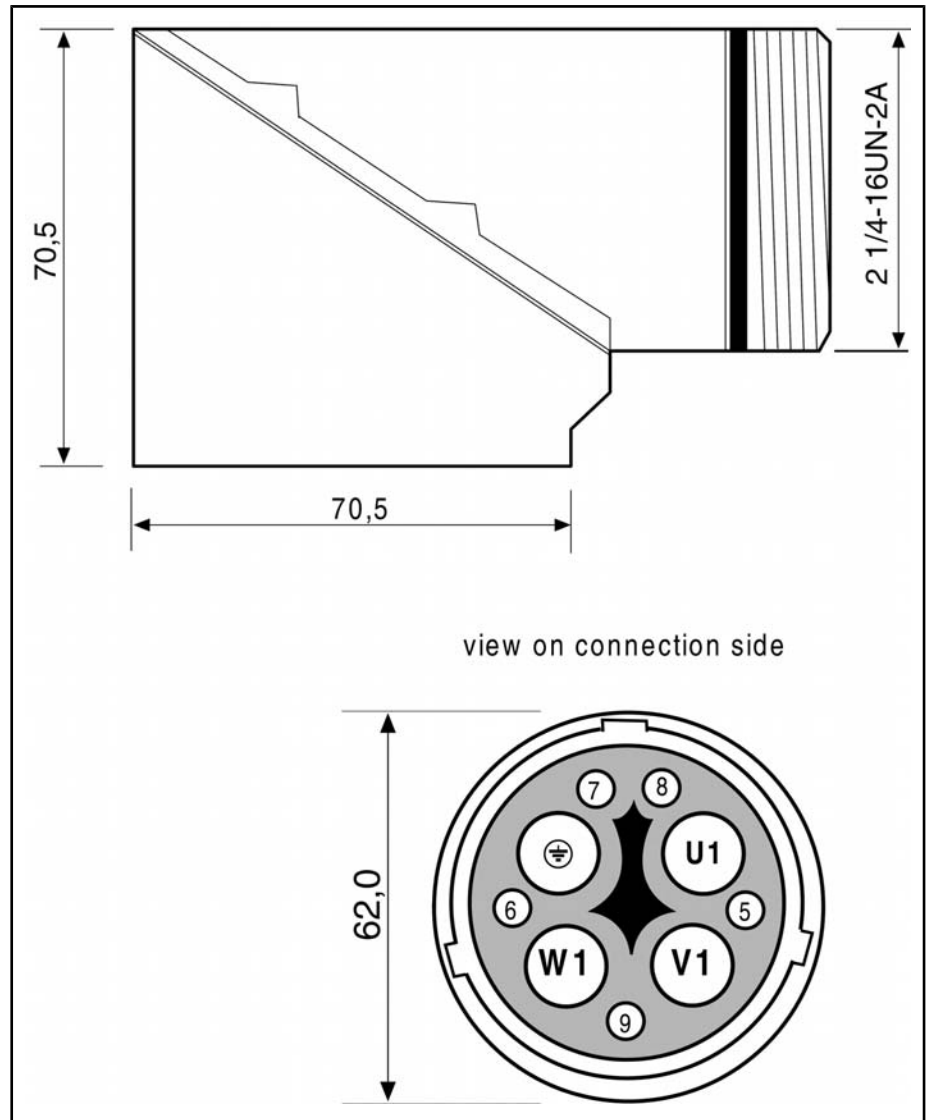

Fig. 8-20: RLS1300 Flange Socket

Mechanical data

Protection class	Number of pins	Temperature range	Contact type
IP66 / IP67 plugged	3 + PE + 5	-40 °C to +125 °C	Pin

Fig. 8-21: Mechanical data

Electrical data

Rated voltage	Continuous rated current	Degree of pollution	Overvoltage category
700V	100A	3	III (according to DIN VDE 0110)

Fig. 8-22: Electrical data

Connection Techniques

Contact assignment

U1	Power	
V1	Power	
W1	Power	
PE	Grounding	
5	Temperature sensor KTY84 (T1 TM+)	
6	Temperature sensor KTY84 (T2 TM-)	
7	Holding brake (Br+ / +24V)	Option
8	Holding brake (Br- / 0V)	
9	n.c.	

Fig.8-23: RLS1300 – contact assignment for MSK motors

8.4.2 RLS1301 Power Connector

The connector RLS1301 is used as a connection for **MSK100, MSK101** motors and as a power coupling.

Graphical representation

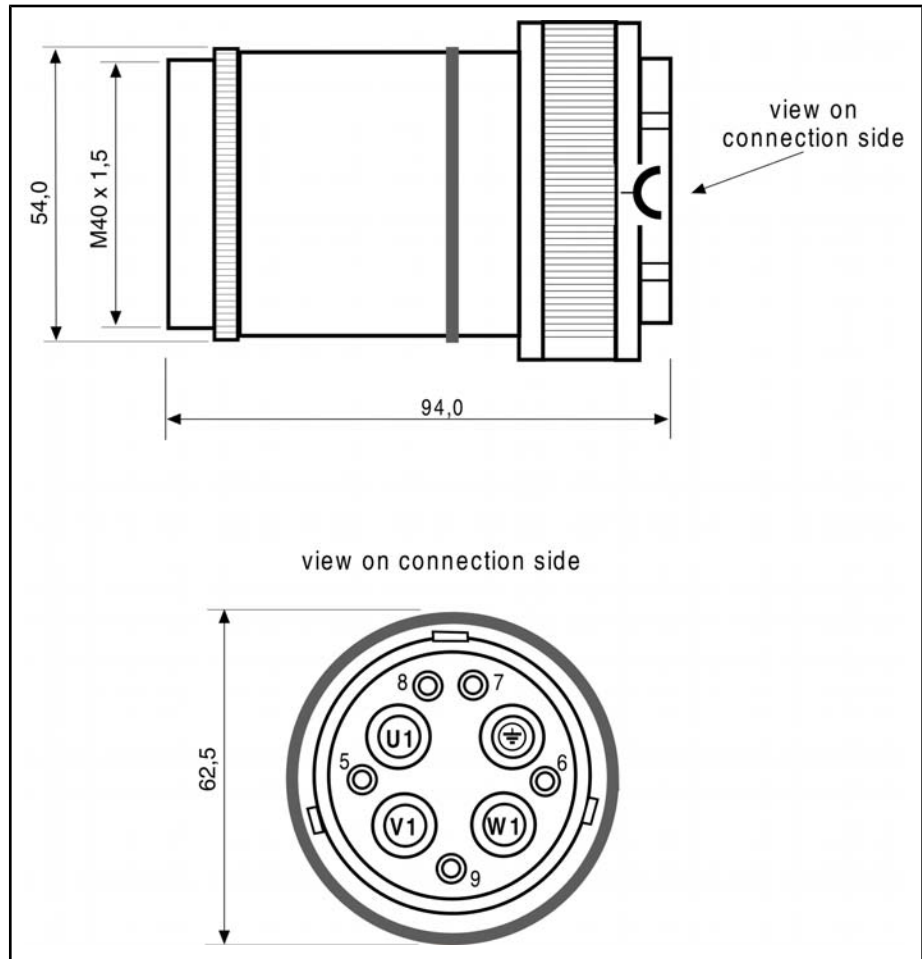

Fig.8-24: Flange socket RLS1301

Mechanical data

Protection class	Number of pins	Temperature range	Contact type
IP66 / IP67 plugged	3 + PE + 5	-40 °C to +125 °C	Socket

Fig.8-25: Mechanical data

Electrical data

Rated voltage	Continuous rated current	Degree of pollution	Overvoltage category
700V	100A	3	III (according to DIN VDE 0110)

Fig.8-26: Electrical data

Contact assignment

U1	Power U1	
V1	Power V1	
W1	Power W1	
PE	Grounding	
5	Temperature sensor KTY84 (T1 TM+)	
6	Temperature sensor KTY84 (T2 TM-)	
7	Holding brake (Br+ / +24V)	Option
8	Holding brake (Br- / 0V)	
9	Brake / temp. shield	

Fig.8-27: RLS1301 – contact assignment for MSK motors

Order designation for plugs

Ordering type	Power wire cross-section	Clamping area of the cable outer diameter
RLS1301/C03	1,5 / 2,5	The cable gland is not in the scope of delivery and must agree to the outer diameter of the cable. Thread on the plug-in connector M40 x 1.5. You can find further information within the documentation „Rexroth Connection Cable, DOK-CONNEC-CABLE*STAND-AU□□-EN-P“
RLS1301/C06	4,0 / 6,0	
RLS1301/C10	10,0	
RLS1301/C16	16,0	
RLS1301/C25	25,0	
RLS1301/C35	35,0	

Fig.8-28: Order designation for RLS1301 plug-in connectors

Connection Techniques

8.5 Encoder connector

8.5.1 RGS1000 Flange Socket, RGS1003 Flange Socket

The encoder is connected to IndraDyn S motors using a 10-pin flange socket.

Graphical display RGS1000

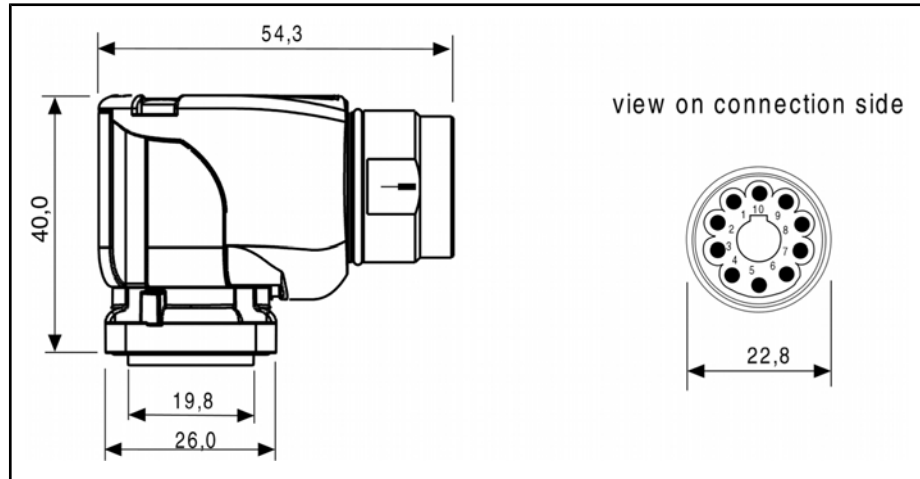

Fig.8-29: RLS1100 Flange Socket

Mechanical data

Protection class	Number of pins	Temperature range	Contact type
IP66 / IP67 plugged	10	-40 °C to +125 °C	Pins

Fig.8-30: Mechanical data

Electrical data

Rated voltage	Continuous rated current	Degree of pollution	Overvoltage category
125 V		3	III (according to DIN VDE 0110)

Fig.8-31: Electrical data

Contact assignment

Pin	Encoders S1, M1 (Hyperface)	Encoders S2, M2 (EnDat 2.1)
1	VCC_Encoder	VCC_Encoder
2	GND_Encoder	GND_Encoder
3	A+	A+
4	A -	A -
5	B +	B +
6	B -	B -
7	EncData +	EncData +
8	EncData -	EncData -
9	n.c.	EncCLK +
10	n.c.	EncCLK -

Fig.8-32: Contact assignment RGS1000, RGS1003

8.5.2 RGS1001 Power Connector

The flange socket RGS1001 is used as a connection for IndraDyn S motors and as a coupling.

Graphical representation

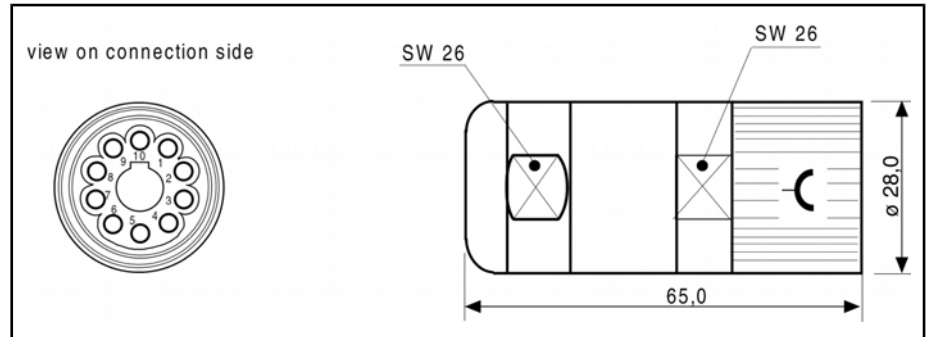

Fig. 8-33: RGS1001 power connector

Mechanical data

Protection class	Number of pins	Temperature range	Contact type
IP66 / IP67 plugged	10	-40 °C to +125 °C	Socket

Fig. 8-34: Mechanical data

Electrical data

Rated voltage	Continuous rated current	Degree of pollution	Overvoltage category
125 V		3	III (according to DIN VDE 0110)

Fig. 8-35: Electrical data

Contact assignment

Pin	Rexroth INK0448 wire colors
1	BN 0.5mm ²
2	WH 0.5mm ²
3	GN 0.25mm ²
4	BN 0.25mm ²
5	PK 0.25mm ²
6	GY 0.25mm ²
7	BU 0.25mm ²
8	VT 0.25mm ²
9	BK 0.25mm ²
10	RD 0.25mm ²
Total shielding over housing	

Fig. 8-36: Contact assignment

Order designation for plugs

Ordering type	Contact diameter	Terminal area, outer cable diameter [mm]
RGS1001/C02	1,0	7,5 – 9,0

Fig. 8-37: Order designation for RGS1001 plug

8.6 Connection Cable

8.6.1 Dimensioning of Power Cables

Heed the current information on the motor type label and observe the installation and ambient conditions in your type of application.



The machine/system manufacturer is responsible for selecting the cable cross-sections.

Observe the regulations of the country where the motors are to be used. USA: see National Electric Code (NEC), National Electrical Manufacturers Association (NEMA), Underwriters Laboratories (UL) regulations as well as local building regulations.

The following table shows the current rating of Bosch Rexroth and PVC cables depending on the method of installation at an ambient temperature of +40°C.

Cross-section in mm ²	Current rating according to VDE 0298 Part 4, Rexroth cable in A _{eff} Installation mode B2	Current rating according to EN 60204 PVC cable in A _{eff}			
		Installation type B1	Installation type B2	Installation type C	Installation type E
1,0	13,0	10,4	9,6	11,7	11,5
1,5	15,7	13,5	12,2	15,2	16,1
2,5	22,6	18,3	16,5	21	22
4	29,6	25	23	28	30
6	38,3	32	29	36	37
10	53,0	44	40	50	52
16	71,3	60	53	66	70
25	93,9	77	67	84	88
35	117,4	97	83	104	114
50	146,1	---	---	123	123

Fig.8-38: Current rating

The current rating is dependent on the way that the cables are installed. The following figure shows the methods of installation according to EN 60204-1 (1993) and VDE 0298, Part 4.

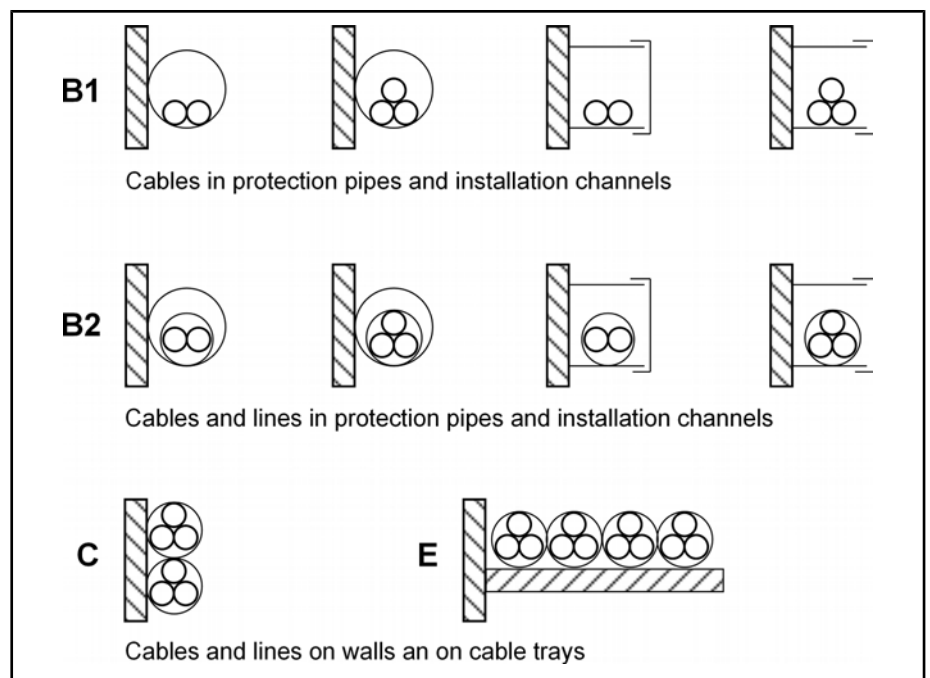

Fig. 8-39: Installation methods



Dimension the connection cable depending on the type of application according to DIN VDE 0298, Part 4, EN 60204-1.

8.6.2 Ready-Made Connection Cables

Connection Cable Rexroth provides ready-made power and encoder cables. The following documentation is available to help select cables.



You can find additional information ...

- in the documentation "**Selection Data Connection Cables**"; **DOK-CON-NEC-CABLE*STAND-AUxx-EN-P**. All available power and encoder cables, as well as the combinations for IndraDyn S motors, are described here.



Note: If installation modes that are not covered in classification "B2" according to EN 60204-1 (1993) are required, larger cable cross-sections may need to be used!

8.6.3 Cable Layout

A distance of at least 100 mm must be maintained between the power and the encoder cables; otherwise, a metallic cable duct with separating bars must be used.

Connection Techniques

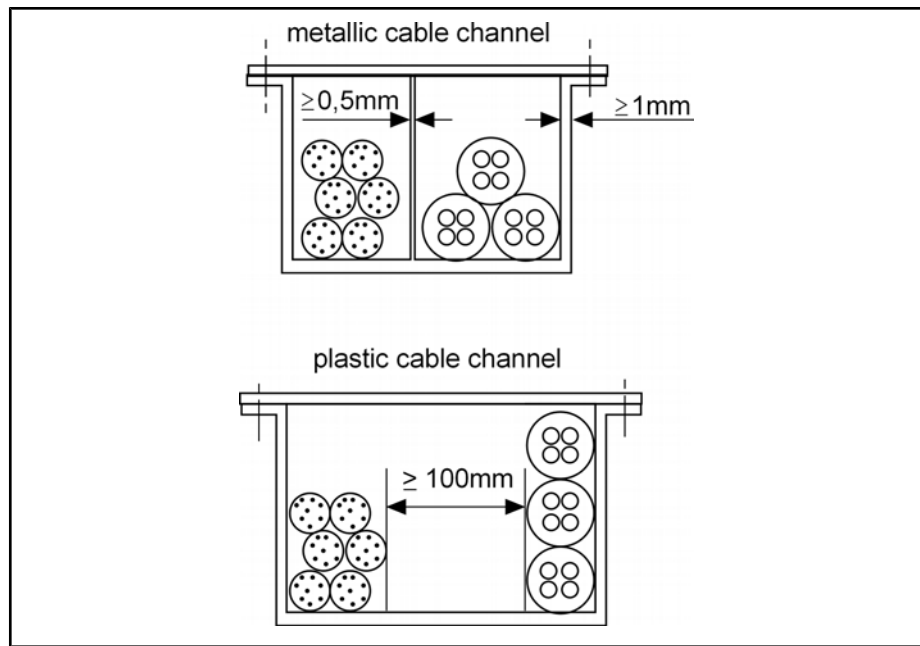

Fig.8-40: Cable duct variants

Do not position encoder/signal cables near radio frequency devices, magnetic fields (transformers, throttles, etc.) or power lines.

8.6.4 Line Lengths

The maximum available line length for power and encoder cables is limited to 75 m.

Note that the line length can be limited by:

- connectors (number > 2)
- the switching frequency of the drive controllers (e.g. 4kHz, 8kHz)
- the EMC behavior



Observe the notes for the IndraDrive drive controllers and the EMC layout in the Project Planning manual.

8.7 Motor Cooling System

8.7.1 Connection Techniques Fan Units

Fan units are designed with connectors in protection class IP 65. Additionally, connectors are delivered with the fan unit, which have to be connected line-side. Please, observe the notes in [chapter 7.3 "Fan Units for MSK Motors" on page 126](#).

8.7.2 Connection Technique Liquid Cooling

The following motors offer the possibility to liquid-cooling.

Motor	Connection
MSK071 MSK101	G1/8"

Fig.8-41: MSK overview cooling connections

Connection Techniques

Installation materials, like tubes and fixing clamps, do not belong to the scope of delivery. Choose a supply-tube with correct internal diameter d_i . The following figure shows possible connection variants.





Connection mode	Drawing			
Tube olive	Motor 	Tube olive with R1/8" thread 	Tube 	Tube clip 
Quick coupling	Motor 	Coupling with R1/8" thread 	Coupling with clamped screw connection 	
Clamped connection	Motor 	Clamped connection with R1/8" thread 	Tube 	

Fig.8-42: Connection variants liquid cooling

Additional information about motor operation with liquid cooling [chapter 9.11.3 "Liquid cooling" on page 170](#).

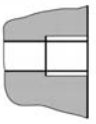
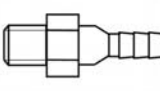
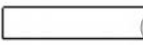
9 Operating Conditions and Application Notes

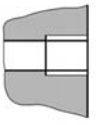
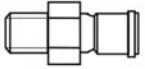
9.1 Ambient Conditions

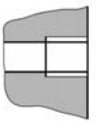
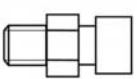
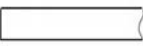
9.1.1 Setup elevation and ambient temperature

The stated motor performance data, according to EN 60034-1 are valid for:

Ambient temperature	0°C to 40°C
Set-up elevation	0 to 1000 m above sea level

Fig.9-1: Ambient temperature, setup elevation (in operation)

When exceeding the given limits, the performance data of the motors must be reduced.

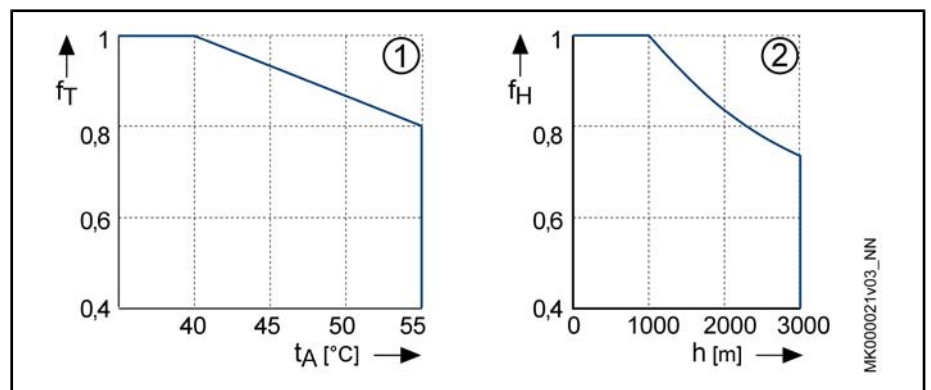

- ① Utilization depending on the ambient temperature
- ② Utilization depending on the setup elevation
- f_T Temperature utilization factor
- t_A Ambient temperature in degrees Celsius
- f_H Height utilization factor
- h Setup elevation in meters

Fig.9-2: Derating ambient temperature, setup elevation (in operation)

Ambient temperature > 40°C	Setup elevation > 1,000 m
Ambient temperature > 40°C and Setup elevation > 1,000 m	
$M_{0_red} = M_0 \cdot f_T$	$M_{0_red} = M_0 \cdot f_H$
$M_{0_red} = M_0 \cdot f_T \cdot f_H$	

Fig.9-3: Derating ambient temperature, setup elevation (in operation)

9.1.2 Humidity / Temperature

Ambient climatic conditions are defined into different classes according to DIN EN 60721-3-3, Table 1. They are based on observations made over long periods of time throughout the world and take into account all influencing quantities that could have an effect, such as the air temperature and humidity.

Based on this table, Rexroth recommends class 3K4 for continuous use of the motors.

This class is excerpted in the following table.

Operating Conditions and Application Notes

Environmental factor	Unit	Class 3K4
Low air temperature	°C	+5 ¹⁾
High air temperature	°C	+40
Low rel. air humidity	%	5
High rel. air humidity	%	95
Low absolute air humidity	g/m ³	1
High absolute air humidity	g/m ³	29
Speed of temperature change	°C/min	0,5

1) Rexroth permits 0°C as the lowest air temperature.
 Fig.9-4: Classification of climatic environmental conditions according to DIN EN 60721-3-3, Table 1

9.1.3 Vibration

Sinusoidal Vibrations

Sine-shaped vibrations occur in stationary use; depending on their intensity, they have different effects on the robustness of the motors.

The robustness of the overall system is determined by the weakest component. Based on DIN EN 60721-3-3 and DIN EN 60068-2-6, the following values result for Rexroth motors:

Direction	Maximum permissible vibration load (10-2,000 Hz)	
	Encoder S1, M1	Encoder S2, M2
axial	10 m/s ²	10 m/s ²
radial	30 m/s ²	10 m/s ²

Fig.9-5: Permissible vibration load for MSK motors

9.1.4 Shock

The shock load of the motors is indicated by providing the maximum permitted acceleration in non-stationary use, such as during transport.

Damage to functions is prevented by maintaining the limit values specified.

Based on DIN EN 60721-3-3 and DIN EN 60068-2-6, the following values result for Rexroth motors:

Frame size	Maximum permitted shock load (6ms)	
	axial	radial
MSK030	10 m/s ²	1,000 m/s ²
MSK040		
MSK050		
MSK060	10 m/s ²	500 m/s ²
MSK061		
MSK070	10 m/s ²	300 m/s ²
MSK071		
MSK076		
MSK100	10 m/s ²	200 m/s ²
MSK101		

Fig.9-6: Permitted shock load for MSK motors

9.2 Protection Class

The motors are divided into corresponding protection classes (IP) regarding their applicability for different ambient conditions. These protection classes (IP) are described in DIN EN 60529. The protection of the device is signed with a double-digit number. The **first characteristic numeral** defines the degree of protection against contact and penetration of foreign particles. The **second code numeral** defines the degree of protection against water.

1st code number	Degree of protection
6	Protection against penetration of dust (dust-proof); complete contact protection
4	Protection against penetration of solid foreign bodies, more than 1 mm in diameter
2	Protection against penetration of solid foreign bodies, more than 12.5 mm in diameter
2nd code number	Degree of protection
7	Protection against harmful effects if temporarily immersed in water
5	Protection against a water jet from a nozzle directed against the housing from all directions (jet water)
4	Protection against water splashing against the housing from all directions (splashwater)

Fig.9-7: IP protection classes

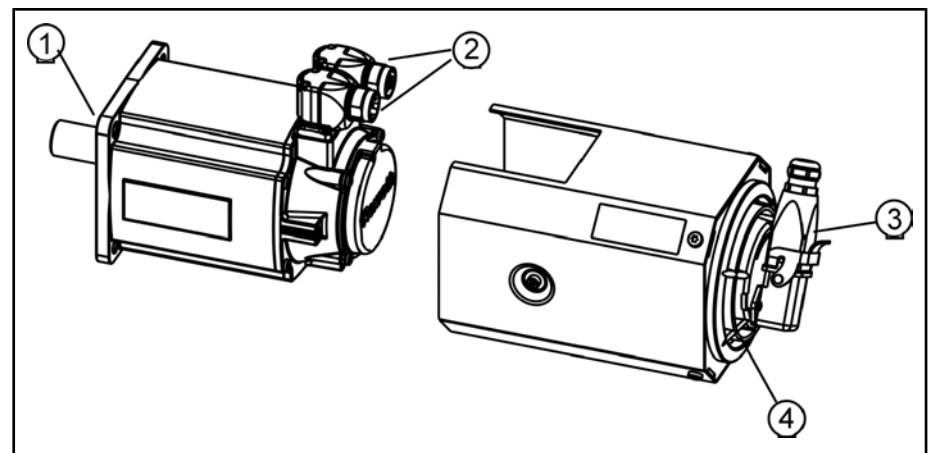

- ① Motor housing and output shaft with shaft sealing ring
- ② Plug-in in connected condition
- ③ Fan motor and connector
- ④ Fan screen

Fig.9-8: IP protection class range for MSK motors

The IndraDyn S motor construction corresponds with the following protection class according to DIN VDE 0470, Part 1, ed. 11/1992 (EN 60 529):

Operating Conditions and Application Notes

Motor area	Protection class	Comment
① motor housing, output shaft	IP 65	Standard design
② connected motor connector at correct assembly	IP 65	Standard design
② connected motor connector at correct assembly and use of sealing air	IP 67	only with the accessory sealing air!
③ connected fan motor and connector	IP 65	Accessory fan unit
④ fan screen	IP 24	

Fig.9-9: IP protection class for the motors



The inspections for the second ID number are executed with fresh water. If cleaning is effected using high pressure and/or solvents, coolants, or penetrating oils, it might be necessary to select a higher degree of protection.

9.3 Compatibility with Foreign Materials

All Rexroth controls and drives are developed and tested according to the state of the art.

However, since it is impossible to follow the continuing further development of every material with which our controls and drives could come into contact (e.g. lubricants on tool machines), reactions with the materials that we use cannot be ruled out in every case.

For this reason, you must execute a compatibility test between new lubricants, cleansers, etc. and our housings and device materials before using these products.

9.4 Design and Installation Positions

IndraDyn S motors are available in design B05. Please refer to the table below for the conditions of installation permissible according to EN 60034-7:1993.

Motor design	Permissible conditions of installation		
	Description	Sketch	Setup
B05	IM B5		Flange mounting on the drive end of the flange
	IM V1		Flange attached on the drive side of the flange; drive side pointing down
	IM V3		Flange attached on the drive side of the flange; drive side pointing down

Fig.9-10: Installation positions



DANGER

Penetration of fluids! If motors are attached according to IM V3, fluid present at the output shaft over a prolonged time may penetrate and cause damage to the motors.

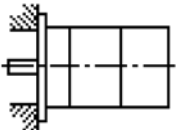
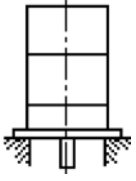
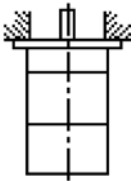
⇒ For that reason, ensure that fluid cannot be present at the output shaft.

9.5 Housing Varnish

The housing painting of the motors consists of a black (RAL9005) 2K-Epoxyd-harz coating based on Epoxyd-Polyamid-Resin in water.

Chemically resistant against	Limited resistant against	No resistance against
diluted acids and alkaline solutions	organic solvents	concentrated acids/brines
water, sea-water, sewage	hydraulic oil	
current mineral oil		

Fig.9-11: Painting resistance

It is permitted to provide the housing with additional varnish (coat thickness no more than 40 µm). Check the adhesion and resistance of the new paint coat before applying it.

9.6 Output Shaft

9.6.1 Smooth Shaft

The recommended standard model for IndraDyn S motors provides a force-actuated, zero-backlash shaft-hub connection with a high degree of quiet running. Use clamping sets, clamping sleeves or clamping elements to couple the machine elements to be driven.

Operating Conditions and Application Notes

9.6.2 Output Shaft with Key

The optional fitting spring according to DIN 6885, Sheet 1, version 08-1968, permits keyed transmission of torques with constant direction, with low requirements for the shaft-hub connection.

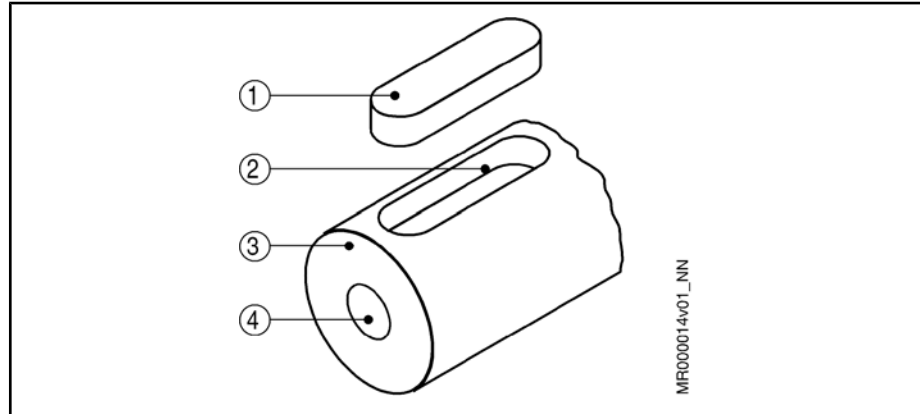

- ① Fitting spring
- ② Fitting spring groove
- ③ Motor shaft
- ④ Centering hole

Fig.9-12: IndraDyn S drive shaft with fitting spring

The machine elements to be driven must additionally be secured in the axial direction via the centering hole on the end face.



CAUTION

Shaft damage! In case of intense reversing operation, the seat of the fitting spring may deflect. Increasing deformations in this area can then lead to breakage of the shaft!

⇒ Preferably, drive output shafts should be used.

Balancing with a complete fitting spring

IndraDyn S motors are balanced with the **complete** key. Hence, the machine element to be driven must be balanced without a fitting spring.



Modifications to the keys may be made only by the user himself and on his own responsibility. Bosch Rexroth does not provide any warranty for modified fitting springs or motor shafts.

9.6.3 Output Shaft with Shaft Sealing Ring

IndraDyn S motors are designed with radial shaft sealing rings according to DIN 3760 – design A.

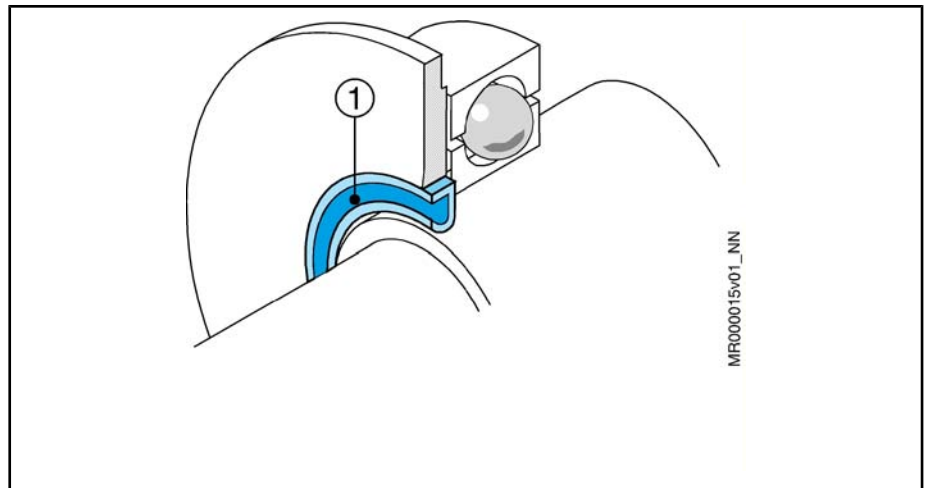

① Radial shaft sealing ring
Fig.9-13: IndraDyn S radial shaft sealing ring

Wear Radial shaft sealing rings are rubbing seals. Hence, they are subject to wear and generate frictional heat.

Wear of the rubbing seal can be reduced only if lubrication is adequate and the sealing point is clean. Here, the lubricant also acts as a coolant, supporting the discharge of frictional heat from the sealing point.

- Prevent the sealing point from becoming dry and dirty. Always ensure adequate cleanliness.



Under normal environmental conditions, the shaft seal is greased for its lifetime. Under unfavorable environmental conditions (e.g. grinding dust, metal shavings), maintenance could be necessary.

Resistance The materials used for the radial shaft sealing rings are highly resistant to oils and chemicals. The performance test for the particular operating conditions lies, however, within the machine manufacturer's responsibility.

As of the publication date of this document, the following material assignment is applicable:

Motor	Sealing material	Abbreviation
IndraDyn S	Therban	HNBR

Fig.9-14: IndraDyn S shaft sealing ring



The complex interactions between the sealing ring, the shaft and the fluid to be sealed, as well as the particular operating conditions (frictional heat, soiling, etc.), do not allow calculation of the lifetime of the shaft sealing ring.

Vertical installation positions IM V3

The degree of protection on the flange side of motors with a shaft sealing ring is IP 65. Hence, tightness is ensured only in case of splashing fluids. Fluid levels present on side A require a higher degree of protection. For vertical installation position (shaft at the top) of the motor, please observe the additional notes in [chapter 9.4 "Design and Installation Positions "](#) on page 160 .

Note on construction

Rexroth recommends that any direct contact of the drive shaft and the radial shaft sealing ring with the processing medium (coolant, material corrosion) caused by the machine or system construction should be avoided.

Operating Conditions and Application Notes

9.7 Bearing and Shaft Load

9.7.1 General

During operation, both radial and axial forces act upon the motor shaft and the motor bearings. The construction of the machine, the selected motor type and the attachment of driving elements on the shaft side must be adapted to one another to ensure that the load limits specified are not exceeded.

9.7.2 Radial Load, Axial Load

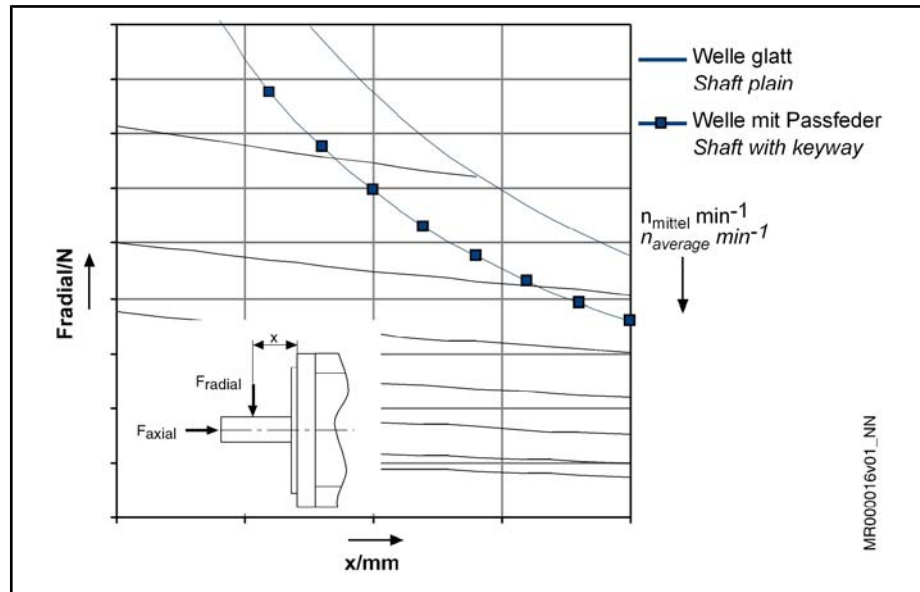

Fig.9-15: Example of a shaft load diagram

Maximum permitted radial force

The maximum permissible radial force $F_{\text{radial_max}}$ depends on the following factors:

- Shaft break load
- Point of application of force x (see chapter „Technical Data“)
- Shaft design (plain; with keyway)

Permittable radial force

The permitted radial force F_{radial} depends on the following factors:

- Arithmetic mean speed (n_{mittel})
- Point of application of force x (see chapter „Technical Data“)
- Bearing Lifetime

Permittable axial force

The maximum permitted axial force F_{axial} is proportional to the radial force. The maximum permitted axial force F_{axial} is specified in the Technical Data, in the "Shaft load" section.

Mean speed

The initialization and deceleration times can be ignored in the calculation if the time in which the drive is operated at a constant speed is significantly greater than the acceleration and deceleration time. In the exact calculation of the mean speed according to the following example, the run-up and braking times are taken into account.

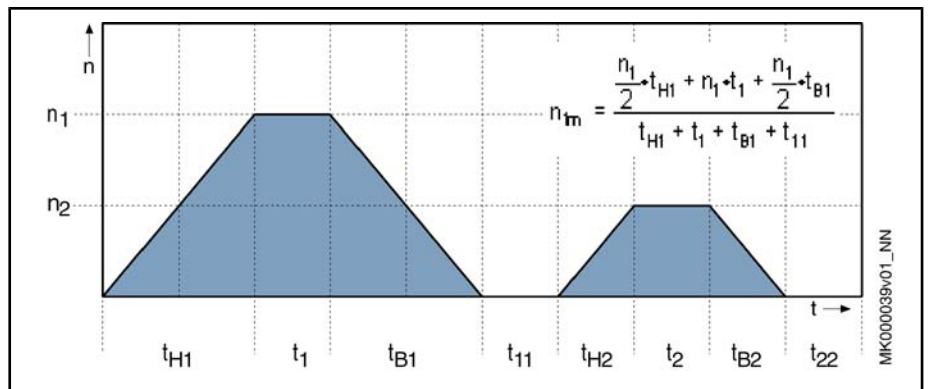

$n_{1m}; n_{2m}$ mean speed in section x
 $n_1; n_2$ processing speed
 $t_{H1}; t_{H1}$ run-up time
 $t_1; t_2$ processing time
 $t_{B1}; t_{B2}$ braking time
 $t_{11}; t_{22}$ standstill time
Fig.9-16: Mean speed

A complete processing cycle can consist of several sections with different speeds. In this case, the average is to be generated from all the sections.

9.7.3 Bearing Lifetime

The bearing lifetime is an important criterion for the availability of IndraDyn motors.

If IndraDyn S-motors are operated within the limits specified for radial and axial loads, the bearing lifetime is as follows:

Bearing Lifetime $L_{10h} = 30\,000$ operating hours

(calculated according to ISO 281, ed. 12/1990)

This applies to all IndraDyn motors based on the following:

- The permitted loads from the corresponding chapter „Technical Data“ are never exceeded.
- The motor is operated under the permitted conditions for use and in the permitted ambient temperature range of 0° to +40° C.
- The „mean speed“ driven over the entire operating cycle conforms with the characteristic curves for the grease lifetime from the corresponding section „Technical Data“, whereby:

$$n_m < n_{m(t_F=30000h)}$$

n_m Mean speed
 $n_{m(t_F)}$ mean speed for which a grease lifetime of 30,000 h can be expected.

Fig.9-17: Mean speed

Differing loads can have the following effects:

- Premature failure of the bearing due to increased wear or mechanical damage.
- Reduction of the grease lifetime leads to premature failure of the bearing.
- Avoid exceeding the load limits.

Mechanical bearing lifetime with increased radial force

In other cases, the bearing lifetime is reduced as follows:

Operating Conditions and Application Notes

$$L_{10h} = \left(\frac{F_{radial}}{F_{radial_ist}} \right)^3 \cdot 30000$$

L_{10h} (Bearing lifetime according to ISO 281, ed. 12/1990)
 F_{radial} Determined permissible radial force in N (Newtons)
 F_{radial_ist} Actually acting radial force in N (Newtons)
 Fig.9-18: Calculation of the bearing service life L_{10h} if the permissible radial force F_{radial} is exceeded

 Under no circumstances may the actually acting radial force F_{radial_ist} be higher than the maximum permissible radial force F_{radial_max} .

9.8 Attachment of Drive Elements

For all attachments of drive elements to the drive shaft, such as

- Gearboxes
- Couplings
- Gear pinion

it is imperative that the following notes are observed.

Gearbox mounting on motors

Are gearboxes mounted on motors, the thermal coupling of the motors on machines or constructions changes.

Depending on the gearbox type, the heat development on the gearbox is different. The heat dissipation of the motor via the flange is reduced in every case when a gearbox is mounted. This must be heeded at project planning.

A reduction of the given performance data is necessary, to do not overload motors when using gearboxes.

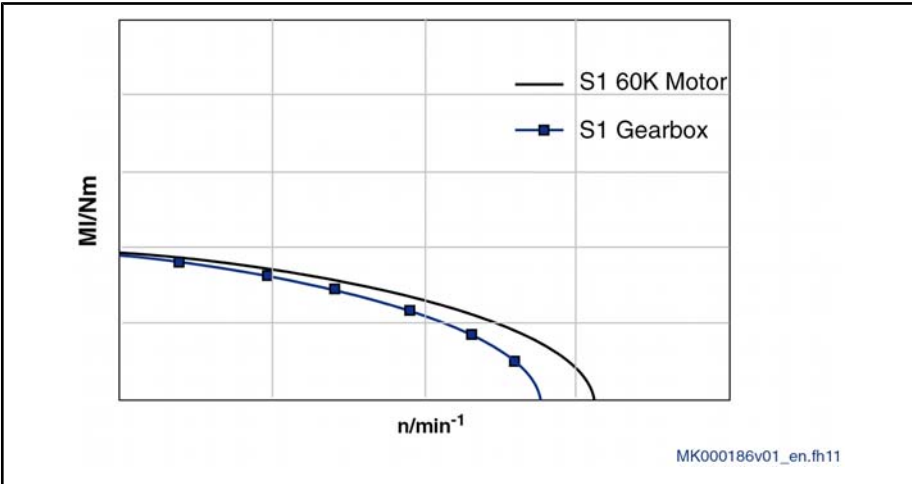



Fig.9-19: S1 characteristic curve of gearboxes

 The indicated torques in the characteristic curves of the motor have to be reduced by **10-20%** when mounting gearboxes.

Please, heed all further notes and specifications within this documentation for the used gearboxes.

Overterminated Bearing

Generally, redundant bearings are to be avoided by all means when connecting drive elements. The tolerances inevitably present in such cases will lead to

additional forces acting on the bearing of the motor shaft and, should the occasion arise, to a distinctly reduced service life of the bearing.



If redundant attachment cannot be avoided, it is absolutely necessary to consult with Bosch Rexroth.

Couplings

The machine construction and the drive elements used must be carefully adapted to the motor type so that the loading limits of the shaft and the bearing are not exceeded.



When connecting extremely stiff couplings, the radial force which constantly changes the angular position may cause an impermissibly high load on the shaft and bearing.

Ball bearing pinion or helical teeth drive pinion

Owing to thermal effects, the flange-sided end of the output shaft may shift by 0.6 mm in relation to the motor housing. If skew bevel driving pinions or bevel gear pinions directly attached to the output shaft are used, this change in position will lead to

- a shift in the position of the axis if the driving pinions are not defined axially on the machine side,
- a thermally dependent component of the axial force if the driving pinions are defined axially on the machine side. This causes the risk of exceeding the maximum permissible axial force or of the play within the gears increasing to an impermissible degree.



In such cases, drive elements should be preferably used with their own bearings which are connected to the motor drive shaft via axially compensating couplings.

9.9 Holding Brakes

9.9.1 General

The holding brakes of the IndraDyn S motors works according to the principle „electrically-released“ . Non-operative closed holding brakes open when applying the operating voltage.

The electrically-released holding brake is used to hold the axes at a standstill and when the "controller enable" signal is off. When the power supply voltage loss and the controller is enabled, the electrically-released brake will automatically shutdown.



Do not use the holding brake as an operational brake for moving axles.

If the holding brake is engaged repeatedly on a drive in motion or the rated brake torque is exceeded, premature brake wear can occur.

Observe the safety requirements during the system design.

Operating Conditions and Application Notes



Bodily harm by hazardous movements due to falling or sinking axes!

Secure vertical axes against falling or sinking after disconnection:

- lock the vertical axes mechanically,
- provide an external braking / collecting / clamping device, or
- ensuring sufficient equilibration of the vertical axes.

⇒ The serially delivered, from the control device driven holding brakes themselves, **are not** suited for personal safety!

Ensure protection of persons by superordinate fail-safe measures.

Cordon off the hazardous area by means of a safety fence or a safety screen.



Observe supplementary DIN and recommendations.

For European countries:

- **DIN EN 954 / 03.97 on security-related parts of controllers.**
- **Leaflet Vertical axes (Editor: Süddeutsche Metall - Berufsgenossenschaft Fachausschuss Eisen und Metall II, Wilhelm-Theodor-Römheld-Str.15, 55130 Mainz, Germany)**

For US:

- See National Electric Code (NEC), National Electrical Manufacturers Association (NEMA) as well as local building regulations.

The following is generally valid: the national terms must be observed!

9.9.2 Dimension of Holding Brakes

General

Holding brakes on motors of Rexroth are basically not designed for service braking. The effective braking torques are physically conditionally different in static and dynamic operation.

Normal Operation	Fault Condition (EMERGENCY STOP)
In normal operation , using the holding brake for clamping of an axis standstill, the brake's static torque (M_4) rating in the data sheets applies directly as static friction (M_4) – stiction (friction coefficient μ_H).	In fault conditions (i.e., EMERGENCY STOP) , where the holding brake is used to stop a moving axis, the "dynamic braking torque", or sliding friction (friction factor μ_G) applies.
$M_4 > M_{dyn}$ Therefore, note the following description of dynamic dimensioning.	

Fig.9-20: *Dynamic sizing*

Dynamic sizing

The load torque must be smaller than the minimum dynamic torque M_{dyn} which the holding brake can provide. Otherwise the dynamic holding brake torque is not sufficient to stop the axes.

If a mass is to be decelerated in a defined time or in a defined route, the additional mass moment of inertia of the whole system must be taken into account.

To ensure construction safety, reduce the required holding torque to 60% of the static holding torque (M_4) of the holding brake.

Safety Notes Holding Brakes

The permanent magnetic brake is no safety brake. This means, a torque reduction by non-influenceable disturbance factors can occur (**see DIN EN 954/03.97 or the leaflet about vertical axes SMBG**).

Particularly heed:

- Corrosion on friction surfaces, as well as dust, perspiration and sediments reduce the braking effect.
- Grease may not hit the friction surface.
- Over voltage and too high temperatures can weaken the permanent magnets and therewith the brake.

Engaging of the brake is no longer ensured, if the air gap among armature and pole is improper heightened by deterioration. In this case, no braking occurs.

9.9.3 Drive of Holding Brakes

The holding brakes are driven over the function drive enable (AF) by the IndraDrive control devices. Details about overview and control possibilities are described within the function description of IndraDrive control devices.

The following conditions have to be ensured during operation to make a safe function of the holding brake sure.

Power supply voltage	Under worst installation conditions of the connection cables and in worst load condition of the supply, a voltage with a tolerance of 24V +/-10% must be provided on the motor .
Monitoring of undervoltage	If a voltage divergence occurs due to a failure during operation, this failure must be identified and corrected immediately. For failure detection, we recommend a monitoring device of the undervoltage.
Functional test	Before start-up and in operation, the function of the holding brake must be tested in periodic intervals of, e.g., 8 hours. A defined torque is generated by the motor, which actuates the motor insignificantly. It is tested, if the holding brake released completely. For further information, please see firmware-function description of IndraDrive drive devices.

9.10 Acceptances and Authorizations

9.10.1 CE-Sign

Declaration of conformity Certificate of conformity certifying the structure of and compliance with the valid EN standards and EC guidelines are available for all IndraDyn S motors. If necessary, these certificates of conformity can be requested from the responsible sales office.

The CE symbol is applied to the motor type label of IndraDyn S motors.



Fig.9-21: CE symbol

9.10.2 UR, cUR Listing

The MSK motors listed below have been presented to the UL authorities "Underwriters Laboratories Inc.®"- authorities „Underwriters Laboratories Inc.®“

Operating Conditions and Application Notes

E239913 MSK040B, -C; MSK050B, -C; MSK060B, -C; MSK070C, -D; MSK071D, -E

E163211 MSK030B, -C ; MSK061C; MSK076C

The motors have been approved with a file number by the UL authorities and have been marked on their motor type label with the following sign:



Fig.9-22: cUR mark

9.10.3 CCC (China Compulsory Certification)

The test symbol CCC is a compulsory marking for safety and quality of products distributed in China.

IndraDyn S motors are not liable to certification regarding CCC in China (status when printing this documentation).

(CCC = China Compulsory Certification)

9.11 Motor Cooling System

9.11.1 Natural Convection

Rexroth motors in standard design are self-cooling motors. The heat dissipation occurs over the natural convection to the ambient air and by heat conduction onto the machine construction.



Pollution of the motors reduces the heat dissipation. Attend to tidiness!

9.11.2 Fan Units

Fan units are available for certain motor types. The stated power data within the section Technical Data are designated with the index „S“ for surface. You will find explanations for Technical Data of the available fan units in [chapter 7.3 "Fan Units for MSK Motors"](#) on page 126.

9.11.3 Liquid cooling

General

Rexroth motors in liquid-cooled design are suited for extreme loads, e.g. duration, start, stop-operation with high repetition rates. MSK motors with liquid cooling are signed in the type code with "FN" under point 5 "Cooling mode".

Abbrev. Column	1									2																		
	1	2	3	4	5	6	7	8	9	0	1	2	3	4	5	6	7	8	9									
Example	M	S	K	x	x	x	x	-	x	x	x	x	-	F	N	-	x	x	-	x	x	x	-	N	N	N	N	
5. Cooling mode																												
5. 1 Liquid cooling																												
5. 2 Natural convection																												

Fig.9-23: MSK motors with liquid cooling (type code designation)

The heat dissipation occurs over the used coolant, released via a downstream heat exchanger to the ambient air.

Core duct

Coolant lines can be designed either as

- pipeline or as
- tubing system.



Owing to the turning points inevitably present in pipeline systems (e.g. 90-degree elbows), high pressure losses develop in the cooling lines. For that reason, we recommend that tubing systems be used.

When selecting the coolant lines, please be absolutely sure to take the pressure drop within the system into consideration. If greater lengths are used, the inside diameter of the lines should, therefore, at least be 9 mm and be reduced only shortly before being connected to the motor.

Coolant The data specified in the documentation relate to **water as coolant**.

Operating pressure

A maximum coolant supply pressure of **3 bar** applies to all MSK motors, regarding the pressure effectively existing directly at the coolant connection of the motor.

Please note that additional screwed or branch connections in the cooling circuit can reduce the flow and supply pressure of the coolant.

Pressure drop The flow in the coolant in the drive components is subject to changes in cross-section and direction. For that reason, there are friction and turning losses. These losses show as the pressure drop Δp .

The pressure drop Δp_n of the liquid-cooled motors is specified in the technical data. It relates to the specified flow volume of water as coolant. If the flow volume is converted to a different temperature increase, the pressure drop must be taken from the characteristic curve below.

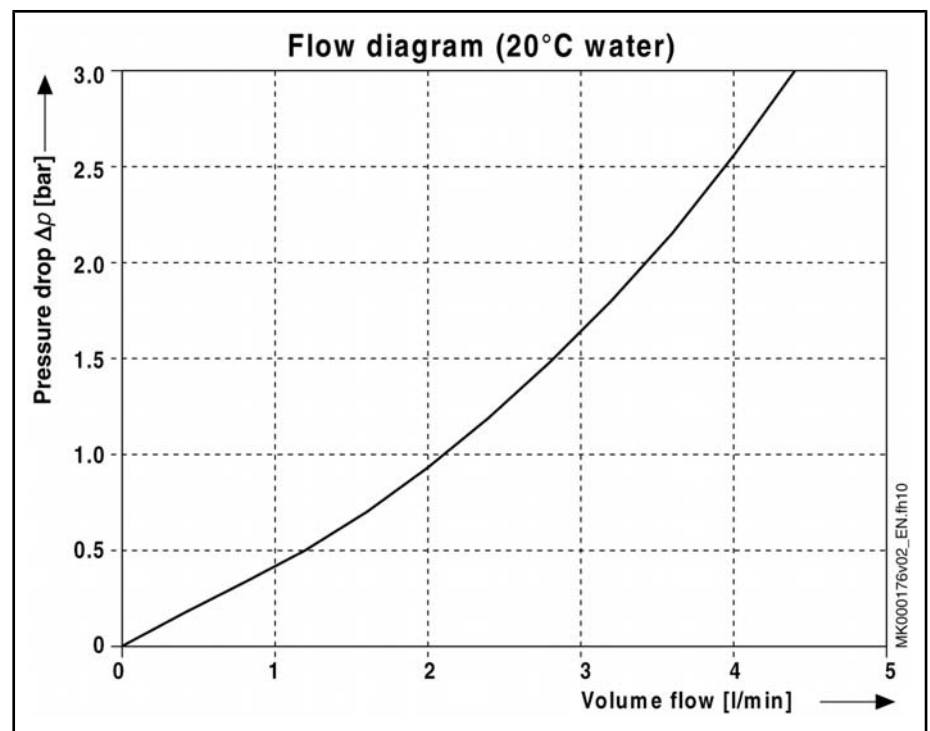

Fig.9-24: Discharge-diagram for MSK motors



If a different coolant is used, a different coolant-specific flow diagram is applicable.

Operating Conditions and Application Notes

Coolant

Only MSK motors with the option "FN" are allowed to be operated via an external connected cooling system.

The heat of the transformed motor power loss P_V is dissipated using the cooling system. MSK motors may only be operated if the coolant supply is ensured. The cooling system must be rated by the machine manufacturer in such a way that all requirements regarding flow, pressure, purity, temperature gradient etc. are maintained in every operating state.



CAUTION

Impairment or loss of motor, machine or cooling system!

- ⇒ Heed the manufacturer's instructions when constructing and operating cooling systems.
- ⇒ Do not use any lubricants or cutting materials from operating processes.

All information and technical data are based on water as the coolant. If other coolants are used, these data no longer apply and must be recalculated.

A cooling with floating water from the supply network is not recommended. Calcareous water can cause deposits or corrosion and damage the motor and the cooling system.

For corrosion protection and for chemical stabilization, the cooling water must have an additional additive which is suitable for mixed-installations with the materials acc. to [chapter "Coolant" on page 172](#)).

The utilization of aggressive coolants, additives, or cooling lubricants can cause irreparable motor damages.

- Use systems with a closed circulation and a fine filter $\leq 100 \mu\text{m}$.
- Heed the environmental protection and waste disposal instructions at the place of installation when selecting the coolant.

Aqueous solution

Aqueous solutions ensure reliable corrosion protection without significant changes of the physical property of the water. The recommended additives contain no materials harmful to water.

Emulsion with Corrosion Protection

Corrosion protection oils for coolant systems contain emulsifiers which ensure a fine distribution of the oil in the water. The oily components of the emulsion protect the metal surfaces of the coolant duct against corrosion and cavitation. Herewith, an oil content of 0.5 – 2 volume percent has proved itself.

Does the corrosion protection oil compared with the corrosion protection has also the coolant pumping lubricant, then the oil content of 5 volume percent is necessary.

- Heed the instructions of the pumping manufacturer!

Coolant additive

Example for coolant additives:

Description	Manufacturer
1%...3%-Solutions	
Aquaplust 22	Petrofer, Hildesheim
Varidos 1+1	Schilling Chemie, Freiburg
33%-Solutions	
Glycoshell	Deutsche Shell Chemie GmbH, Eschborn
Tyfocor L	Tyforop Chemie GmbH, Hamburg
OZO antifreeze	Deutsche Total GmbH, Düsseldorf

Description	Manufacturer
Aral cooler antifreeze A	ARAL AG, Bochum
BP antifrost X 2270 A	Deutsche BP AG, Hamburg
mineral grease concentrate emulsive	
Shell Donax CC (WGK: 3)	Shell, Hamburg

Fig.9-25: Coolant additives



Bosch Rexroth can give no general statements or investigations regarding applicability of process-related coolants, additives, or operating conditions.

The performance test for the used coolants and the design of the liquid coolant system are generally the responsibility of the machine manufacturer.

Used Materials

The coolant used with MSK motors comes into contact with the materials named in chapter "Technical Data – Liquid Cooling".

In dimensioning and operating the cooling system, the machine manufacturer has to exclude all chemical or electro-chemical interactions with ensuing corrosion or decomposition of motor parts.

Coolant inlet temperature

IndraDyn S motors (option "FN") are designed according to DIN EN 60034-1 for operating with +10...+40°C coolant inlet temperature. This temperature range must be strictly observed. At higher coolant temperatures, the reduction of the available torque is increased. Because of high coolant temperature gradients, lower temperatures can lead to destruction of the motor.



Install systems in the cooling circuit for monitoring flow, pressure and temperature.

Setting of the inlet temperature

Observe the temperature range permitted and consider the existing ambient temperature when setting the coolant inlet temperature.

The lower limit of the recommended coolant inlet temperature can be limited compared to the existing ambient temperature. To avoid condensation, a value of max. 5°C below the existing ambient temperature is permitted as the lowest temperature to be set.

Example 1:

Permittable coolant inlet temperature range +10... +10... +40°C

Ambient temperature: +20°C

Set coolant inlet temperature: +15... +40°C

Example 2:

Permittable coolant inlet temperature range +10... +10... +40°C

Ambient temperature: +30°C

Set coolant inlet temperature: +25... +40°C

Operating Conditions and Application Notes



The coolant inlet temperature must be set in a temperature range of +10°C - +40°C and may be only max. 5°C under the existing ambient temperature to avoid condensation.

9.12 Motor Temperature Overview

9.12.1 General

The motor temperature overview occurs via two – independent of each other - working systems.

- Temperature sensor
- Temperature Model

and ensures, therewith, the highest protection of the motors against irreversible damage by thermal overload.

9.12.2 Temperature sensor

The motor temperature overview is ensured via the temperature sensor of type KTY84, which is built into the stator. The measured motor temperature is controlled via the following marginal values:

- Motor-warning temperature (140°C)
- Motor-disconnection temperature (150°C)

The marginal values are filed within the encoder memory of the MSK motors.

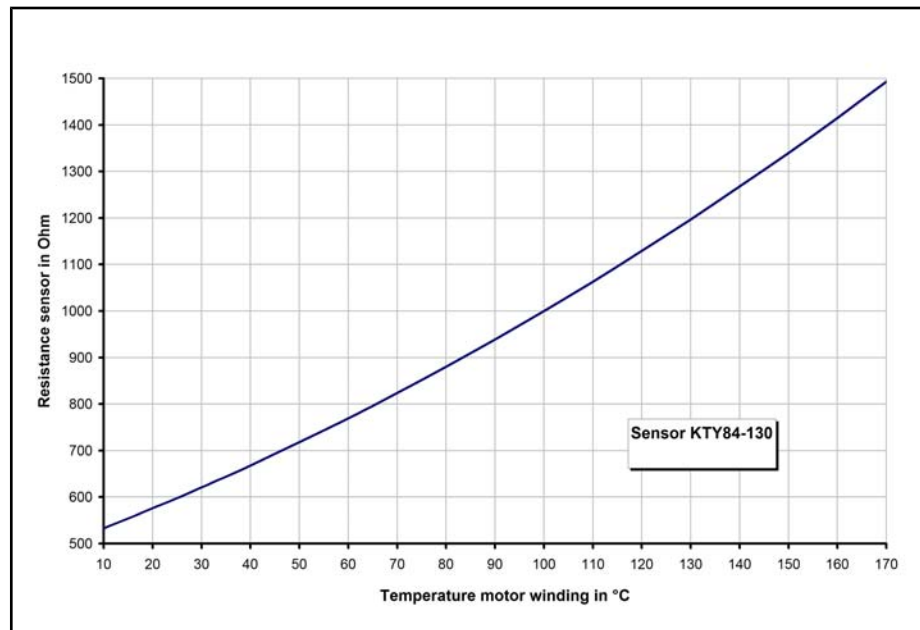

Fig.9-26: Characteristic curves KTY84-130

The IndraDrive drive devices overview the functionality of the temperature sensors.

For further information, please refer to the function description for IndraDrive drive devices.

9.12.3 Temperature Model

Description in preparation!

10 Handling, Transport and Storage

10.1 Supplied Condition

10.1.1 General

On delivery, the IndraDyn S motors are packed in cardboard boxes or crates. Packing units on pallets are secured by retaining straps.



WARNING

Injuries due to uncontrolled movement of the retaining straps when cutting!

⇒ Maintain a sufficient distance and carefully cut the retaining straps.

On delivery from the factory, the motor drive shaft and the connectors have protective sleeves. Remove the protective sleeves just before assembly.

10.1.2 Inspection at the Factory

All IndraDyn S motors undergo the following inspections:

- | | |
|------------------------|---|
| Electrical test | <ul style="list-style-type: none"> • High-voltage test according to DIN EN 60034-1/02/99 • Insulation resistance according to EN 60204-1/1.92, Section 20.3. • Ground conductor connection according to EN 60204-1/1.92, Section 20.3. • Test of winding resistance |
| Mechanical test | <ul style="list-style-type: none"> • Concentricity and position tolerances of shaft end and fastening flange according to DIN 42955/12.81 • Axial eccentricity of the flange face to the shaft according to DIN 42955/12.81. • Axial eccentricity of the centering shoulder to the shaft according to DIN 42955/12.81. • Test brake holding torque (option) |

10.1.3 Test on the Customer Side

Since all IndraDyn S motors undergo a standardized inspection procedure, high-voltage tests on the customer side are not required. Motors and components could be damaged if they undergo several high-voltage inspections.



DANGER

Destruction of motor components by improperly executed high-voltage inspection! Invalidation of warranty!

⇒ Avoid repeated inspections.

⇒ Observe the regulations of EN 60034-1 (= VDE 0530-1).

10.2 Identification and Checking of the Supplied Goods

10.2.1 Shipping documents and delivery note

The total scope of a delivery can be seen in the delivery note or waybill. However, the contents of a delivery can be distributed over several packages.

Each individual package can be identified using the shipment label attached to the outside.

Handling, Transport and Storage

10.2.2 Name plate

Each device has an individual type label containing the device designation and technical information.

- After receiving the goods, compare the ordered and the supplied type. Submit claims concerning deviations immediately.

Motor The motor is delivered with its own separate name plate. This is attached to the motor housing. In addition, a second name plate is attached using two-side tape onto the original motor name plate. The second can be put where visible on the machine, if the original name plate on the motor be concealed by parts of the machine.

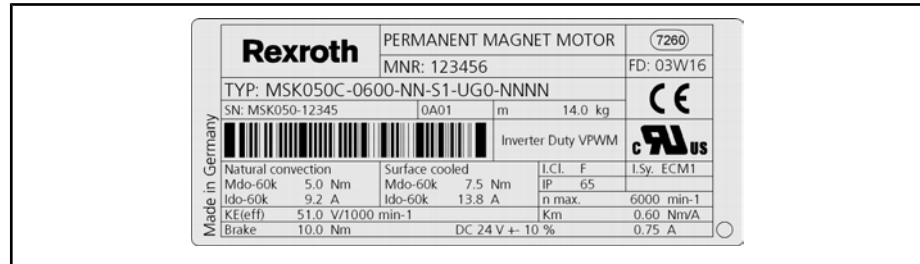

Fig.10-1: Type label (example: IndraDyn S)

The name plate is provided for

- Identification of the motor
- Procurement of spare parts in case of a failure,
- Service information.



The type designation of the motor is also filed in the encoder data memory.

10.3 Handling of the Equipment



CAUTION

Damages or injuries and invalidation of the warranty due to improper handling!

- ⇒ Avoid mechanical stressing, throwing, tipping or dropping of the products.
- ⇒ Use only suitable lifting equipment.
- ⇒ Never lift up the motor on the optional fan housing.
- ⇒ Use suitable protective equipment and protective clothing during transport.
- ⇒ Protect the products from dampness and corrosion.

On delivery, IndraDyn S motors have protective sleeves and covers on the drive shaft and the flange sockets. During transport and storage, the protective sleeves must remain on the motor.

- Remove the protective sleeves just before assembly.
- Also use the protective sleeves if you return the goods.

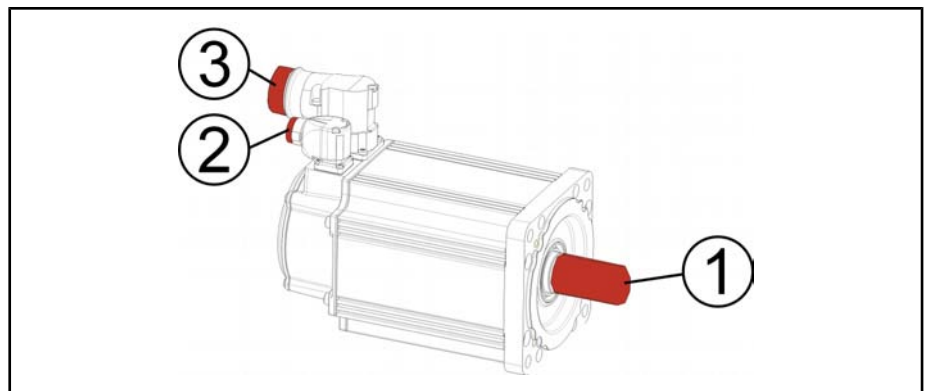

- ③ Power plug protective sleeve
- ② Encoder plug protective sleeve
- ① Shaft protective sleeve

Fig.10-2: IndraDyn S protective sleeves

- Avoid damage to the motor flange and drive shaft.
- Avoid blows to the drive shaft.

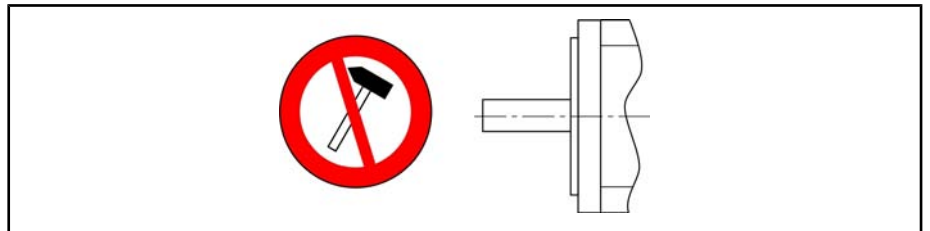

Fig.10-3: Care of the shaft end

Blows to the shaft end damage the encoder and the ball bearings! Drive elements such as pulleys, clutch discs, gears, etc. may be attached or removed only by uniformly heating the drive elements or using suitable mounting or dismantling equipment.

- Use cranes with lifting sling belts to lift the motors.

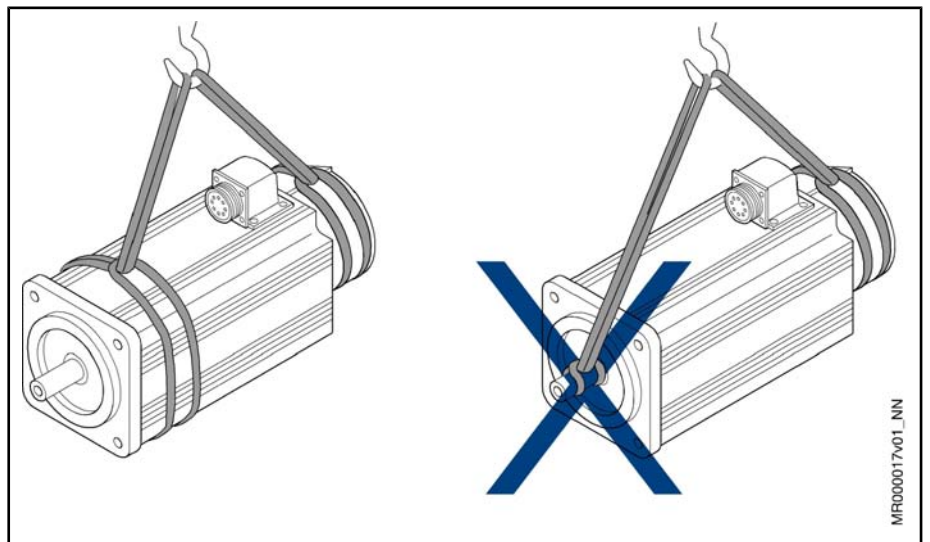

Fig.10-4: Lifting and transporting motors by means of lifting sling belts

10.4 Transport of the Equipment

Requirements for transport according to DIN EN 60271-3-2.

Handling, Transport and Storage

Environmental factor	Unit	Class 2K3
Low air temperature	°C	- 25
High air temperature	°C	+ 70
Max. rel. air humidity	%	95
Max. absolute air humidity	g/m ³	60
Shock stress	see fig. 9-6 "Permitted shock load for MSK motors" on page 158	

Fig.10-5: Conditions for transport

The following conditions must be maintained during transport:

- Use suitable means for transport and heed the weight of the components. You can find indications of weight on the data sheets or on the type plate of the motor.
- Provide shock absorbability if strong vibrations may occur during transport.
- Transport the motors only in the horizontal position.

10.5 Storage of the Equipment

Requirements for storage according to DIN EN 60271-3-1.

Environmental factor	Unit	Class 1K3
Low air temperature	°C	- 5
High air temperature	°C	+ 45
Low rel. air humidity	%	5
High rel. air humidity	%	95
Low absolute air humidity	g/m ³	1
High absolute air humidity	g/m ³	29
Shock stress	see fig. 9-6 "Permitted shock load for MSK motors" on page 158	

Fig.10-6: Conditions for storage



CAUTION

Damage and invalidation of the warranty due to incorrect storage!

⇒ Store the motors horizontally in a dry, vibration-free, dust-free and corrosion-protected location.

11 Installation

11.1 Safety



WARNING

Injuries due to live parts! Lifting of heavy loads!

- Install the motors only when they are de-energized and not connected electrically.
- Use suitable tackles, protective equipment and protective clothing during transport.

Observe the notes regarding safety found in previous chapters.

Carry out all working steps especially carefully. In this way, you minimize the risk of accidents and damage.

11.2 Skilled Personnel

Any work on the system and on the drives or in their vicinity may be carried out only by appropriately trained technical personnel.

Please make sure that all persons carrying out

- Installation work
- Maintenance, or
- Operational activities

on the system are adequately familiar with the contents of this documentation as well as with all warnings and precautionary measures contained therein.



Qualified skilled personnel are defined as those who have been trained, instructed or are authorized to activate and deactivate, ground and mark electric circuits and equipment according to the technical safety regulations. Qualified technical personnel must possess appropriate safety equipment and have been trained in first aid.

11.3 Mechanical Mounting – Motor Assembly

11.3.1 Mounting the Flange

IndraDyn S motors are designed for flange assembly (frame shape B05). Details for the fastening holes can be found in the corresponding dimension sheet [chapter 5 "Specifications" on page 87](#).

To fix the flange, we recommend using the screws and tightening torques listed in the table below.

Motor Frame Size	Recommended screw size	Tightening torque [Nm]	Minimum strength
MSK030	M4 x 20	3,1	8.8
MSK040	M6 x 20	10,4	8.8
MSK050	M8 x 20	25	8.8
MSK060	M8 x 20	25	8.8
MSK061	M8 x 20	25	8.8
MSK070	M10 x 30	51	8.8

Installation

Motor Frame Size	Recommended screw size	Tightening torque [Nm]	Minimum strength
MSK071	M10 x 30	51	8.8
MSK076	M10 x 30	51	8.8
MSK100	M12 x 40	87	8.8
MSK101	M12 x 40	87	8.8

The indicated screw lengths apply for screwing into steel.

Fig.11-1: Fastening screws



The screwed connections must be able to take up both the force due to the weight of the motor and the forces acting during operation.

11.3.2 Preparation

Prepare the motor assembly as follows:

1. Procure tools, supplies, measuring and test equipment.
2. Check all components for visible damaged. Defective components may not be mounted.
3. Ensure that dimensions and tolerances on the system side are suitable for motor attachment (for details, see the dimension sheet).
4. Check whether all components, assembly surfaces and threads are clean.
5. Ensure that mounting can be done in a dry and clean environment.
6. Ensure that the holder for the motor flange is without burrs.
7. Remove the protective sleeve of the motor drive shaft and keep it for further use.

If the optional holding brake is used

1. Check whether the motor holding brake reaches the holding torque specified in the data sheet. If the brake fails to reach the torque specified, first proceed as described under section 12.4, "Holding Brake Maintenance".

11.3.3 Assembly

- Mount the motor.

Note:

1. Avoid pinching or jamming the centering bundle on the motor side.
2. Avoid damage to the insertion fitting on the system side.
3. Check the fit and precision of the connection before you proceed.

After having mounted the motor mechanically as prescribed, establish the electrical connections.

11.4 Electrical Connection – Motor Connection

11.4.1 General

It is recommended that you use ready-made Rexroth connection cables. These cables provide a number of advantages, such as UL/CSA authorization, extreme load capability and resistance as well as a design suitable for EMC.

**DANGER**

Danger to life and limb due to electrical power! Handling within the range of live parts is extremely dangerous.

- Any work required on the electric system may be carried out only by skilled electricians. It is absolutely necessary to use power tools.
- Before starting work, the system must be de-energized and the power switch be secured against unintentional or unauthorized re-energization.
- Before starting work, the appropriate measuring equipment must be used to check whether parts of the system are still applied to residual voltage (e.g. caused by capacitors, etc.). If yes, wait until these parts have discharged.

**WARNING**

Injuries to persons or property possible! Interrupting or connecting live lines may cause unpredictable dangerous situations or lead to physical damage.

- Connect and disconnect plug connectors only when they are dry and de-energized.
- During operation of the system, all plug connectors must be securely tightened.

**WARNING**

Risk of short-circuit caused by liquid coolant or lubricant! Short-circuits of live lines may cause unpredictable dangerous situations or lead to physical damage.

- Provide open sides of the power connectors with protective caps when installing or replacing drive components.

11.4.2 Connecting the Plug

Power/encoder plugs

When fitting the connector with a threaded connection, proceed as follows:

1. Place the power connector in the correct position onto the thread of the connection housing.
2. Tighten the union nut of the power connector manually. By conducting the cable, the power connector can be steadily brought to its final position.
3. Completely tighten the union nut.



Only completely tightened union nuts guarantee the indicated IP65 protection against water and activate the vibration protection.

11.4.3 Adjusting the Output Direction

The flange sockets can be turned through 240°.

The motor flange socket can be turned if an appropriate plug has been connected. Owing to the leverage of the connected plug, the flange socket can be turned manually to the desired position.

1. Connect the motor power cable to the flange socket.

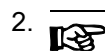

Do not use any tools (e.g. pliers or screwdrivers) to turn the motor flange socket. Mechanical damage to the flange socket when using tools cannot be excluded.

Move the flange socket to the desired output direction by turning the connected plug.

Installation

The desired output direction is set.



Whenever the flange socket is turned, the holding torque in the set position is reduced. To ensure the required holding torque of the flange socket, the output direction should be changed no more than 5 times!

12 Commissioning, Operation and Maintenance

12.1 Commissioning



Material damage due to errors in the controls of motors and moving elements! Unclear operating states and product data!

- Do not carry out commissioning if connections, operating states or product data are unclear or faulty!
- Do not carry out commissioning if the safety and monitoring equipment of the system is damaged or not in operation.
- Damaged products may not be operated!
- Contact Rexroth for missing information or support during commissioning!

The following notes on commissioning refer to IndraDyn S motors as part of a drive system with drive and control devices.

Preparation

1. Keep the documentation of all applied products ready.
2. Check the products for damage.
3. Check all mechanical and electrical connections.
4. Activate the safety and monitoring equipment of the system.
5. Make sure that the optional holding brake is ready for operation. [chapter 12.4.5 "Holding Brakes " on page 185](#)

Execution

When all prerequisites have been fulfilled, proceed as follows:

1. Activate the optional motor cooling fan unit or liquid cooling.
2. Carry out the commission of the drive-system according to the instructions of the respective documentation. You can find the respective information in the functional description of the drive-devices.



Commissioning of drive controllers and the control unit may require additional steps. The inspection of the functioning and performance of the systems is not part of the commissioning of the motor; instead, it is carried out within the framework of the commissioning of the machine as a whole. Observe the information and regulations of the machine manufacturer.

12.2 Operation

Keep the described ambient conditions during operation.

12.3 Deactivation

In the case of malfunctions or maintenance, or to deactivate the motors, proceed as follows:

1. Observe the instructions of the machine documentation.
2. Use the machine-side control commands to bring the drive to a controlled standstill.
3. Switch off the power and control voltage of the drive controller.
4. **Only at motors with blowers:** Switch off the motor protection switch for the motor blower.

5. Switch off the main switch of the machine.
6. Secure the machine against accidental movements and against unauthorized operation.
7. Wait for the discharge time of the electrical systems to expire and then disconnect all electrical connections.
8. Before dismantling, secure the motor and fan unit against falling or movement before disconnecting the mechanical connections.

12.4 Maintenance

12.4.1 General

Synchronous motors of the IndraDyn S series operate maintenance-free within the given operating conditions. However, operation under unfavorable conditions can lead to limitations in availability.

- Increase availability with regular preventive maintenance measures. Heed the information in the maintenance schedule of the machine manufacturer and the service measures described below.



WARNING

Danger of burning via hot surfaces with temperatures over 100°C!

⇒ Touch the motor only after cooling! A cooling time up to 140 minutes can be necessary! The stated thermal time constant in the technical data is a measure for the necessary cooling

- ⇒ Do not work on hot surfaces.
- ⇒ Use safety gloves.



WARNING

Danger of injury due to moving elements!

- Do not carry out any maintenance measures when the machine is running.
- During maintenance work, secure the system against restarting and unauthorized use.

12.4.2 Cleaning

Excessive dirt, dust or shavings may affect the function of the motors adversely, may in extreme cases even cause a failure of the motors. Clean the cooling fins of the motors in regularly intervals (after one year at the latest) to reach a sufficiently high heat emission surface. If the cooling ribs are dirty in part, sufficient heat dissipation via the environmental air is not possible any longer.

An insufficient heat radiation may have undesired consequences. The bearing lifetime is reduced by operation at impermissibly high temperatures (the bearing grease is decomposing). Switchoff caused by overtemperature despite operation on the basis of selected data, because the appropriate cooling is missing.

12.4.3 Bearing

The nominal lifetime of the bearings is $L_{10h} = 30,000$ h according to DIN ISO 281, ed. 1990, if the permissible radial and axial forces are not exceeded. Even if the bearings are loaded with higher forces to a minor degree only, their service life is affected negatively.

The motor bearings should be replaced if

- the nominal bearing service life has been reached,
- running noise comes up



We recommend that bearings are replaced by the Bosch Rexroth Service.

12.4.4 Connection Cable

Check connection cables for damage at regular intervals and replace them, if necessary.

Check any optionally present energy management chains (drag chains) for defects.



DANGER

Death by electrocution possible due to live parts with more than 50V!

- Do not repair any connection lines provisionally. If the slightest defects are detected in the cable sheath, the system must be put out of operation immediately. Then the cable must be replaced.

Check the protective conductor connection for proper state and tight seat at regular intervals and replace it, if necessary.

12.4.5 Holding Brakes

In order to ensure proper functioning of the holding brake, it must be checked before the motors are installed.

Before initial startup

Measure the holding torque of the holding brake. If necessary, grind in the holding brake.

Measure the holding torque of the holding brake

- De-energize the motor and secure it against re-energization.
- Measure the transferable holding torque of the holding brake with a torque wrench. The holding torque of the brakes is stated in the data sheets.

If the holding torque specified in the data sheets is attained, the holding brake is ready for operation. If the holding torque specified in the data sheets is **not reached**, the holding brake must be ground in as described in [page 185](#)

Grinding in the Holding Brake

- With the holding brake closed, manually turn the output shaft by approx. five revolutions and measure the transmittable holding torque of the brake using a torque spanner.
- Measure the holding torque [page 185](#)

If the specified holding torque is not attained after the second grinding-in process, the holding brake is not operable. Notify Rexroth Service.

During operation

If holding brakes are required only sporadically (braking cycle >48 h) during operation, film rust may develop on the brake friction surface.

To prevent the holding torque from dropping below the specified holding torque, we recommend the grinding procedure described below:

Grind in the holding brake	
Interval	Once in 48 h
Grinding-in speed	100 min ⁻¹

Commissioning, Operation and Maintenance

Grind in the holding brake	
Number of grinding-in revolutions	1
Ambient temperature	-20°C to +50°C

Fig.12-1: Grinding the holding brake (rule)



The option of automatically implementing the grinding-in routine in the program run is described in the documentation of the particular drive controllers.



During normal operation, it is not necessary to grind in the brake. It is sufficient if the brake is activated twice a day by removing the controller enable signal.

12.5 Troubleshooting

In preparation

12.6 Dismantling



DANGER

Fatal injury due to errors in activating motors and working on moving elements!

- Do not work on unsecured and operating machines.
- Secure the machine against accidental movements and against unauthorized operation.
- Before dismantling, secure the motor and power supply against falling or movements before disconnecting the mechanical connections.



WARNING

Burning via hot surface with temperatures over 100 °C

- Do not work on hot surfaces.
- Use safety gloves.

⇒ Let the motor cool down, before maintenance. The stated thermal time constant in the technical data is a measure for the cooling. A cooling time up to 140 minutes can be necessary!

- Observe the instructions of the machine documentation.
- Please observe the safety notes.
- Dismantle the motor from the machine. Store the motor properly!

12.7 Waste Disposal

Manufacturing process

The manufacturing process of the products is executed in such a manner that energy and raw materials are optimized; in addition the process permits recycling and the utilization of incidental waste.

Bosch Rexroth regularly tries to replace polluted raw materials and supplies by environmentally friendly alternatives.

Application

Bosch Rexroth products do not contain any kind of dangerous substances which could be released with proper use. Normally, no negative influences for the environment can be assumed.

Forbidden substances	We guarantee that our products include no substances according to chemical ban regulations. Furthermore, our products are free of mercury, asbestos, PCBs and chlorinated hydrocarbons.
Material composition	Basically, our motors contain <ul style="list-style-type: none">• steel• aluminum• copper• brass• magnetic materials• electronic components and modules
Recycling	Most of the products can be recycled due to the high metal proportion. To reach optimum metal recovery, disassembly into individual components is necessary. The metals also contain electrical and electronical components that can be recycled using special separation processes. The hereby arising plastics could be thermally recycled.
Returns	<p>The products manufactured by us can be returned to our premises for waste disposal at no charge. This is possible only if the product does not contain any disturbing adhesions such as oil, grease or other contamination.</p> <p>Furthermore, it is not permitted that the product contains inappropriate foreign materials when it is returned.</p> <p>The products must be delivered postage-free to the following address:</p> <p>Bosch Rexroth AG Electric Drives and Controls Buergermeister-Dr.-Nebel-Strasse 2 97816 Lohr, Germany</p>
Packaging	<p>High-quality products need optimal packaging. The packaging material consists of paper, wood and polystyrene.</p> <p>They can be recycled everywhere.</p> <p>For ecological reasons, a return transport of the packaging should not take place.</p>

13 Appendix

13.1 List of Standards

Standard	Edition	Title	Concordance
98/37/EG	1998-06-22	Guideline 98/37/EC of the European Parliament and the Council dated June 22, 1998, for aligning the legal provisions and administrative regulations of the member states for machines	
89/336/EEC	1989-05-03	Guideline of the Council dated May 3, 1989, for aligning the legal provisions of the member states on electromagnetic compatibility	
DIN EN 50178; VDE 0160	1998-04	Electronic equipment for use in power installations; German version EN 50178:1997	EN 50178(1997-10)
DIN IEC 60364-4-41; VDE 0100 part 410	2003-04	Standard draft) DIN IEC 60364-4-41 , Edition: 2003-04 Electrical installations of buildings – Part 4-41: Protection for safety; Protection against electric shock (IEC 64/1272/CDV:2002)	HD 384.4.41 S2(1996-04); IEC 6036-4-41(1992-10)
DIN 332-2	1983-05	Center holes 60° with thread for shaft ends for rotating electrical machines	
DIN 6885-1	1968-08	Driver connection without pick-up; feather keys, grooves, high shape	
DIN EN 60034-1; VDE 0530 Part 1	2000-09	Rotating electrical machines - Part 1: Rating and performance (IEC 60034-1:1996, modified + A1:1997 + A2:1999); German version EN 60034-1:1998 + A1:1998 + A2:1999	EN 60034-1(1998-05); EN 60034-1/A1(1998-05); EN 60034-1/A2(1999-08); IEC 60034-1(1996-11); IEC 60034-1 AMD 1 (1997-06); IEC 60034-1 AMD 2(1999-05)
DIN VDE 0298-4; VDE 0298 Part 4	2003-08	Application of cables and cords in power installations - Part 4: Recommended current-carrying capacity for sheathed and non-sheathed cables for fixed wirings in buildings and for flexible cables and cords	
DIN EN 60204-1; VDE 0113 Part 1	1998-11	Safety of machinery - Electrical equipment of machines - Part 1: General requirements (IEC 60204-1:1997 + Corrigendum 1998); German version EN 60204-1:1997 (In addition, DIN EN 60204-1 (1993.06) is applicable until 2001.07.01. DIN VDE 60204-1 (1993.06) is applicable until further notice as the reference standard for EN 60204-3-1 (1990.08), which has been published in Germany as DIN EN 60204-3-1 (1993.02).	EN 60204-1(1997-12); IEC 60204-1(1997-10)
DIN 42955	1981-12	Tolerances of shaft extension run-out and of mounting flanges for rotating electrical machinery, test	IEC 60072(1971)
DIN 748-1	1970-01	Cylindrical Shaft Ends for Electrical Machines	IEC 60072(1971)
DIN EN 60034-14; VDE 0530 Part 14	1997-09	Rotating electrical machines - Part 14: Mechanical vibration of certain machines with shaft heights 56 mm and higher; measurement, evaluation and limits of vibration (IEC 60034-14:1996); German version EN 60034-14:1996	EN 60034-14(1996-12); IEC 60034-14(1996-11)

Appendix

Standard	Edition	Title	Concordance
IEC 721-3-3 replaced by DIN EN 60721-3-3	1995-09	Classification of environmental conditions - Part 3: Classification of groups of environmental parameters and their severities; section 3: Fixed use, weatherproof (IEC 60721-3-3:1994); German Version EN 60721-3-3:1995 Changed by DIN EN 60721-3-3/A2 dated July 1997	EN 60721-3-3(1995-01); IEC 60721-3-3(1994-12)
IEC 721-1 replaced by DIN IEC 60721-1	1997-02	Classification of environmental conditions - Part 1: Environmental parameters and their severities (IEC 60721-1:1990 + A1:1992 + A2:1995); German version EN 60721-1:1995 + A2:1995	EN 60721-1(1995-04); EN 60721-1/A2(1995-07); IEC 60721-1(1990-12); IEC 60721-1 AMD 1 (1992-12); IEC 60721-1 AMD 2(1995-04)
DIN EN 60529; VDE 0470 Part 1	2000-09	Degrees of protection provided by enclosures (IP code) (IEC 60529:1989 + A1:1999); German version EN 60529:1991 + A1:2000 (In addition, DIN VDE 0470-1 (1992-11) may still be used until 2003-01-01.)	EN 60529(1991-10); EN 60529/A1(2000-02); IEC 60529(1989-11); IEC 60529 AMD 1(1999-11)
DIN EN 60034-7; VDE 0530 Part 7	1996-06	Rotating electrical machines - Part 7: Classification of types of constructions and mounting arrangements (IM code) (IEC 60034-7:1992); German version EN 60034-7:1993	EN 60034-7(1993-01); IEC 60034-7(1992-12)
DIN 3760	1996-09	Rotary shaft lip type seals	
DIN ISO 281	1993-01	Rolling bearings; dynamic load ratings and rating life; identical with ISO 281:1990	

Fig. 13-1: List of Standards

14 Service & Support

14.1 Helpdesk

Our service helpdesk at our headquarters in Lohr, Germany, will assist you with all kinds of enquiries.

Contact us:

- By phone through the Service Call Entry Center,
Mo - Fr 7:00 am - 6:00 pm CET
+49 (0) 9352 40 50 60
- By Fax
+49 (0) 9352 40 49 41
- By email: service.svc@boschrexroth.de

14.2 Service Hotline

Out of helpdesk hours please contact our German service department directly:

+49 (0) 171 333 88 26

or

+49 (0) 172 660 04 06

Hotline numbers for other countries can be found in the addresses of each region (see below).

14.3 Internet

Additional notes regarding service, maintenance and training, as well as the current addresses of our sales and service offices can be found on

<http://www.boschrexroth.com>

Outwith Germany please contact our sales/service office in your area first.

14.4 Helpful Information

For quick and efficient help please have the following information ready:

- detailed description of the fault and the circumstances
- information on the type plate of the affected products, especially type codes and serial numbers
- your phone / fax numbers and e-mail address so we can contact you in case of questions

Index

A

Alignment 87
Ambient temperature 157
Appropriate use 5
 Uses 5
Aqueous solution 172
Attachments 166
available motor variants 101
Axial load 164

B

Balance characteristics 87
Ball bearing pinion 167
Bearing
 wear 165
Bearing failure 165
Bearing Lifetime 165
Bearing load 164
Brake torque 167

C

CCC- test symbol 170
Centering hole 87
CE-Sign 169
Climatic conditions 157
Compatibility 160
Concentricity 87
Conditions of installation 160
Connection cables 185
Connection technique
 Internal diameter 155
Connection techniques
 operating pressure 171
Constant voltage 17
Continuous stand-still current 16
Coolant 171
Coolant additive 172
Cooling fins 184
Core duct 170
Corrosion Protection 172
Coupling 167
Couplings 166
cUR, UR Listing 169

D

Design 160
Disconnection temperature 174
Drag chains 185
Drive shaft 87, 103

E

Energy management chains 185

F

Flange 87
Foreign materials 160
Foreign systems 3
Frame length 101
Frame size 101

G

Gearbox
 GTE 136
 GTM 136
Gear pinion 166
Getriebe 166

H

heat dissipation 184
Helical teeth 167
Holding brake 104
 grind in 185
Holding brakes 167
 commissioning 185
 Danger notices 168
 Dimension 168
 Drive 169
 electrically-released 167
 Safety notes 169
Housing varnish 87, 161
Humidity
 absolute air humidity 157
 relative air humidity 157

I

Identification 176
Inappropriate use, 6
 Consequences, Discharge of liability 5
Installation positions 160
IP protection class 159

K

key 162
Keyway 87

M

Machine accuracy 15
Mass 17
Materials used 173
Maximum line length 154
Maximum torque 17
Mean speed 164
Moment of inertia of rotor 17
Monitoring of undervoltage 169
Motor cooling
 coolant 172
 coolant temperature 173

Index

Motor design 87
Motor encoder 125

N

Number of pole pairs 17

O

Operating hours 165
Operating Mode 15
Operating time 16
Output shaft, 161
 Key balancing 103
 Smooth output shaft 161
Output Shaft 162
Overterminated bearing 166
Overview 141

P

Peak current 17
Position resolution 125
Pressure drop 171
processing cycle 165
Product 101
Protection class 159

R

Radial load 164
Radial shaft sealing ring 15
Radial shaft sealing rings 162
RGS1000 150
RGS1001 151
RLS1100 142
RLS1101 143
RLS1200 144
RLS1201 145
RLS1300 147
RLS1301 148
running noise 184
Run-out 87

S

Safety instructions for electric drives and controls 7
Sealing air 136

Setup elevation 157

Shaft

 smooth 161
 with key 162
Shaft end 87
Shaft load 164
Shaft Sealing Ring 162
Shock 158
Shock absorbability 178
Sinusoidal Vibrations 158
Sling belts 177
Standards 2
Standstill continuous torque 16
State-of-the-art 5
Storage 178
Systemaccuracy 125

T

Temperature sensor 174
Temperature stroke on the housing 60K 15
Temperature stroke on the winding 100K 15
tightness 163
Torque constant 17
Transport 177

U

UL authorization 169
Umgebungstemperatur 152
UR, cUR Listing 169
Use
 Appropriate use 5
 Inappropriate use 6

V

Varnish 161
Vibration 158
Vibration characteristics 87

W

Warning temperature 174
Winding 101
Winding inductivity 17
Winding resistance 17

Notes

Bosch Rexroth AG
Electric Drives and Controls
P.O. Box 13 57
97803 Lohr, Germany
Bgm.-Dr.-Nebel-Str. 2
97816 Lohr, Germany
Phone +49 (0)93 52-40-50 60
Fax +49 (0)93 52-40-49 41
service.svc@boschrexroth.de
www.boschrexroth.com

